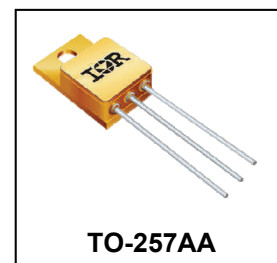

**RADIATION HARDENED
POWER MOSFET
THRU-HOLE (TO-257AA)**
200V, P-CHANNEL
REF: MIL-PRF-19500/712

Product Summary

Part Number	Radiation Level	RDS(on)	I _D	QPL Part Number
IRHY597230CM	100 kRads(Si)	0.515Ω	-8.0A	JANSR2N7548T3
IRHY593230CM	300 kRads(Si)	0.515Ω	-8.0A	JANSF2N7548T3

Description

IRHY597230CM is a part of the International Rectifier HiRel family of products. IR HiRel R5 technology provides high performance power MOSFETs for space applications. These devices have been characterized for both Total Dose and Single Event Effect (SEE) with useful performance up to LET of 80 (MeV/(mg/cm²)). The combination of low RDS(on) and low gate charge reduces the power losses in switching applications such as DC-DC converters and motor controllers. These devices retain all of the well established advantages of MOSFETs such as voltage control, fast switching, ease of paralleling and temperature stability of electrical parameters.

Features

- Single Event Effect (SEE) Hardened
- Fast Switching
- Low RDS(on)
- Low Total Gate Charge
- Simple Drive Requirements
- Hermetically Sealed
- Electrically Isolated
- Ceramic Eyelets
- Light Weight
- ESD Rating: Class 1C per MIL-STD-750, Method 1020

Absolute Maximum Ratings
Pre-Irradiation

Symbol	Parameter	Value	Units
I _D @ V _{GS} = -12V, T _C = 25°C	Continuous Drain Current	-8.0	A
I _D @ V _{GS} = -12V, T _C = 100°C	Continuous Drain Current	-5.0	
I _{DM}	Pulsed Drain Current ①	-32	
P _D @ T _C = 25°C	Maximum Power Dissipation	75	W
	Linear Derating Factor	0.6	W/°C
V _{GS}	Gate-to-Source Voltage	± 20	V
E _{AS}	Single Pulse Avalanche Energy ②	80	mJ
I _{AR}	Avalanche Current ①	-8.0	A
E _{AR}	Repetitive Avalanche Energy ①	7.5	mJ
dv/dt	Peak Diode Recovery dv/dt ③	-12	V/ns
T _J T _{STG}	Operating Junction and Storage Temperature Range	-55 to + 150	°C
	Lead Temperature	300 (0.063 in./1.6 mm from case for 10s)	
	Weight	4.3 (Typical)	g

For Footnotes, refer to the page 2.

Electrical Characteristics @ T_J = 25°C (Unless Otherwise Specified)

Symbol	Parameter	Min.	Typ.	Max.	Units	Test Conditions
BV_{DSS}	Drain-to-Source Breakdown Voltage	-200	—	—	V	$V_{GS} = 0V, I_D = -1.0mA$
$\Delta BV_{DSS}/\Delta T_J$	Breakdown Voltage Temp. Coefficient	—	-0.25	—	V/°C	Reference to 25°C, $I_D = -1.0mA$
$R_{DS(on)}$	Static Drain-to-Source On-Resistance	—	—	0.515	Ω	$V_{GS} = -12V, I_D = -5.0A$ ④
$V_{GS(th)}$	Gate Threshold Voltage	-2.0	—	-4.0	V	$V_{DS} = V_{GS}, I_D = -1.0mA$
G_{fs}	Forward Transconductance	5.1	—	—	S	$V_{DS} = -15V, I_D = -5.0A$ ④
I_{DSS}	Zero Gate Voltage Drain Current	—	—	-10	μA	$V_{DS} = -160V, V_{GS} = 0V$
		—	—	-25		$V_{DS} = -160V, V_{GS} = 0V, T_J = 125^\circ C$
I_{GSS}	Gate-to-Source Leakage Forward	—	—	-100	nA	$V_{GS} = -20V$
	Gate-to-Source Leakage Reverse	—	—	100		$V_{GS} = 20V$
Q_G	Total Gate Charge	—	—	45	nC	$I_D = -8.0A$
Q_{GS}	Gate-to-Source Charge	—	—	12		$V_{DS} = -100V$
Q_{GD}	Gate-to-Drain ('Miller') Charge	—	—	16		$V_{GS} = -12V$
$t_{d(on)}$	Turn-On Delay Time	—	—	25	ns	$V_{DD} = -100V$
t_r	Rise Time	—	—	30		$I_D = -8.0A$
$t_{d(off)}$	Turn-Off Delay Time	—	—	50		$R_G = 7.5\Omega$
t_f	Fall Time	—	—	105		$V_{GS} = -12V$
$L_S + L_D$	Total Inductance	—	6.8	—	nH	Measured from Drain lead (6mm / 0.25 in from package) to Source lead (6mm / 0.25 in from package) with Source wire internally bonded from Source pin to Drain pad
C_{iss}	Input Capacitance	—	1340	—	pF	$V_{GS} = 0V$
C_{oss}	Output Capacitance	—	190	—		$V_{DS} = -25V$
C_{rss}	Reverse Transfer Capacitance	—	20	—		$f = 1.0MHz$

Source-Drain Diode Ratings and Characteristics

Symbol	Parameter	Min.	Typ.	Max.	Units	Test Conditions
I_S	Continuous Source Current (Body Diode)	—	—	-8.0	A	
I_{SM}	Pulsed Source Current (Body Diode) ①	—	—	-32		
V_{SD}	Diode Forward Voltage	—	—	-5.0	V	$T_J = 25^\circ C, I_S = -8.0A, V_{GS} = 0V$ ④
t_{rr}	Reverse Recovery Time	—	—	200	ns	$T_J = 25^\circ C, I_F = -8.0A, V_{DD} \leq -25V$
Q_{rr}	Reverse Recovery Charge	—	—	1.2	μC	$di/dt = -100A/\mu s$ ④
t_{on}	Forward Turn-On Time	Intrinsic turn-on time is negligible (turn-on is dominated by $L_S + L_D$)				

Thermal Resistance

Symbol	Parameter	Min.	Typ.	Max.	Units
$R_{\theta JC}$	Junction-to-Case	—	—	1.67	°C/W
$R_{\theta JA}$	Junction-to-Ambient (Typical Socket Mount)	—	—	80	

Footnotes:

- ① Repetitive Rating; Pulse width limited by maximum junction temperature.
- ② $V_{DD} = -50V$, starting $T_J = 25^\circ C$, $L = 2.5mH$, Peak $I_L = -8.0A$, $V_{GS} = -12V$
- ③ $I_{SD} \leq -8.0A$, $di/dt \leq -340A/\mu s$, $V_{DD} \leq -200V$, $T_J \leq 150^\circ C$
- ④ Pulse width $\leq 300 \mu s$; Duty Cycle $\leq 2\%$
- ⑤ **Total Dose Irradiation with V_{GS} Bias.** -12 volt V_{GS} applied and $V_{DS} = 0$ during irradiation per MIL-STD-750, Method 1019, condition A.
- ⑥ **Total Dose Irradiation with V_{DS} Bias.** -160 volt V_{DS} applied and $V_{GS} = 0$ during irradiation per MIL-STD-750, Method 1019, condition A.

Radiation Characteristics

IR HiRel radiation hardened MOSFETs are tested to verify their radiation hardness capability. The hardness assurance program at IR HiRel is comprised of two radiation environments. Every manufacturing lot is tested for total ionizing dose (per notes 5 and 6) using the TO-3 package. Both pre- and post-irradiation performance are tested and specified using the same drive circuitry and test conditions in order to provide a direct comparison.

Table1. Electrical Characteristics @ Tj = 25°C, Post Total Dose Irradiation ⑤⑥

Symbol	Parameter	100 kRads (Si) ¹		300 kRads (Si) ²		Units	Test Conditions
		Min.	Max.	Min.	Max.		
BV _{DSS}	Drain-to-Source Breakdown Voltage	-200	—	-200	—	V	V _{GS} = 0V, I _D = -1.0mA
V _{GS(th)}	Gate Threshold Voltage	-2.0	-4.0	-2.0	-5.0	V	V _{DS} = V _{GS} , I _D = -1.0mA
I _{GSS}	Gate-to-Source Leakage Forward	—	-100	—	-100	nA	V _{GS} = -20V
I _{GSS}	Gate-to-Source Leakage Reverse	—	100	—	100	nA	V _{GS} = 20V
I _{DSS}	Zero Gate Voltage Drain Current	—	-10	—	-10	μA	V _{DS} = -160V, V _{GS} = 0V
R _{DS(on)}	Static Drain-to-Source ④ On-State Resistance (TO-3)	—	0.505	—	0.505	Ω	V _{GS} = -12V, I _D = -5.0A
R _{DS(on)}	Static Drain-to-Source ④ On-State Resistance (TO-257AA)	—	0.515	—	0.515	Ω	V _{GS} = -12V, I _D = -5.0A
V _{SD}	Diode Forward Voltage ④	—	-5.0	—	-5.0	V	V _{GS} = 0V, I _D = -8.0A

1. Part numbers IRHY597230CM, JANSR2N7548T3

2. Part numbers IRHY593230CM, JANSF2N7548T3

IR HiRel radiation hardened MOSFETs have been characterized in heavy ion environment for Single Event Effects (SEE). Single Event Effects characterization is illustrated in Fig. a and Table 2.

Table 2. Typical Single Event Effect Safe Operating Area

LET (MeV/(mg/cm ²))	Energy (MeV)	Range (μm)	VDS (V)				
			@ VGS = 0V	@ VGS =5V	@ VGS =10V	@ VGS =15V	@ VGS =20V
38 ± 5%	270 ± 7.5%	35 ± 7.5%	-200	-200	-200	-200	-75
61 ± 5%	330 ± 7.5%	31 ± 7.5%	-200	-200	-200	-50	—
84 ± 5%	350 ± 7.5%	28 ± 7.5%	-200	-200	-200	-35	—

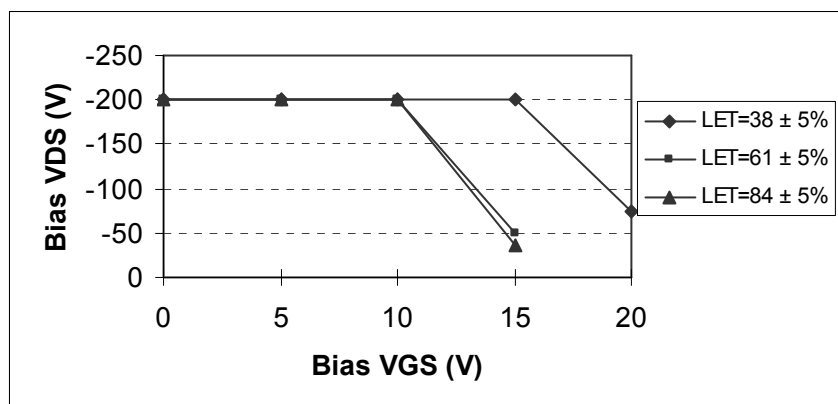

Fig a. Typical Single Event Effect, Safe Operating Area

For Footnotes, refer to the page 2.

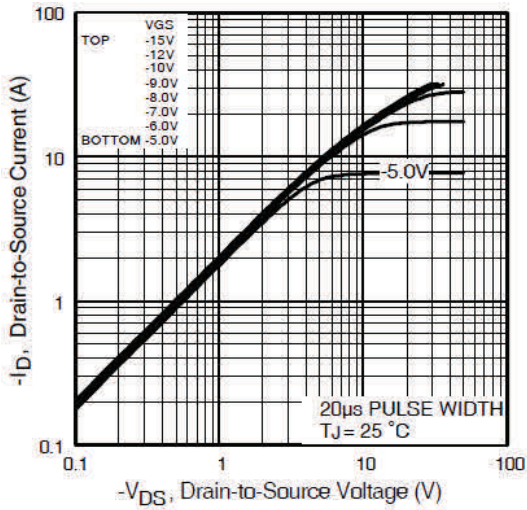

Fig 1. Typical Output Characteristics

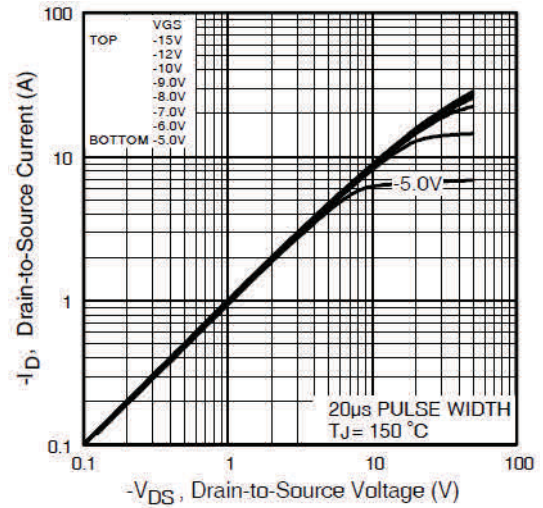

Fig 2. Typical Output Characteristics

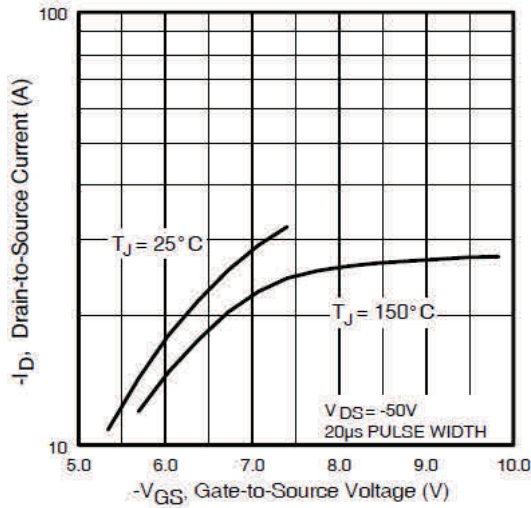

Fig 3. Typical Transfer Characteristics

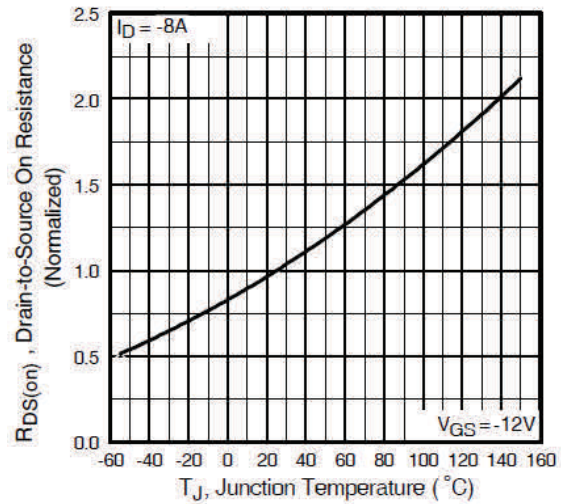

Fig 4. Normalized On-Resistance Vs. Temperature

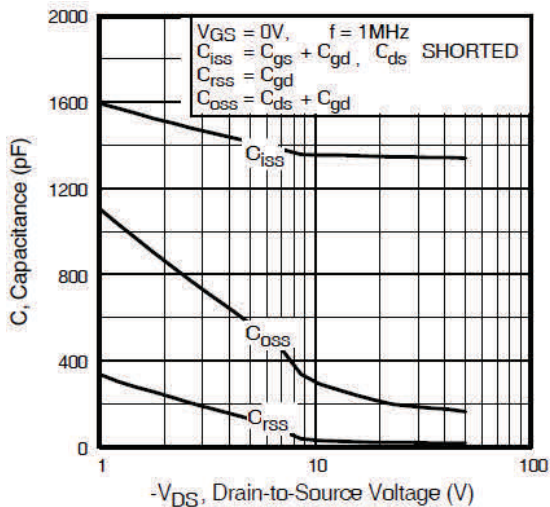

Fig 5. Typical Capacitance Vs. Drain-to-Source Voltage

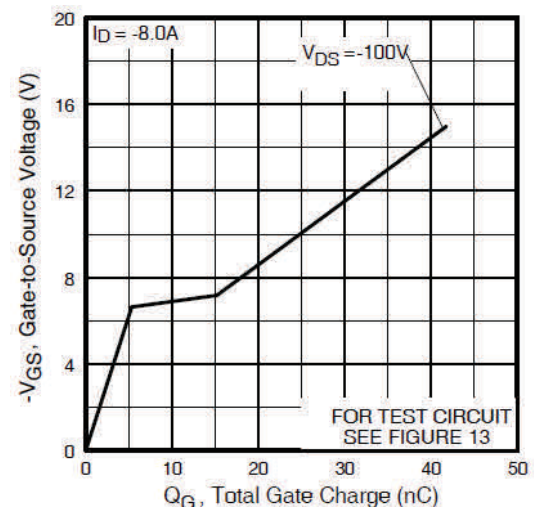

Fig 6. Typical Gate Charge Vs. Gate-to-Source Voltage

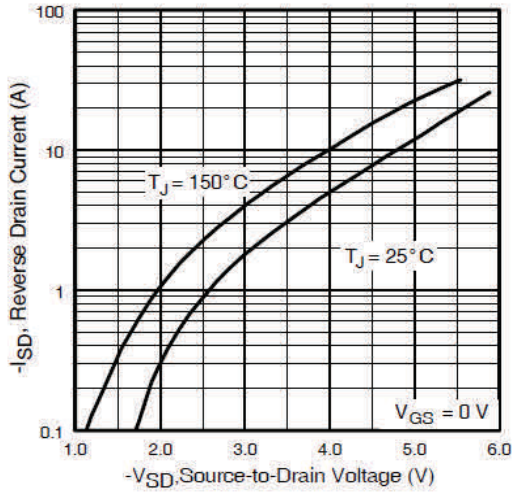

Fig 7. Typical Source-Drain Diode Forward Voltage

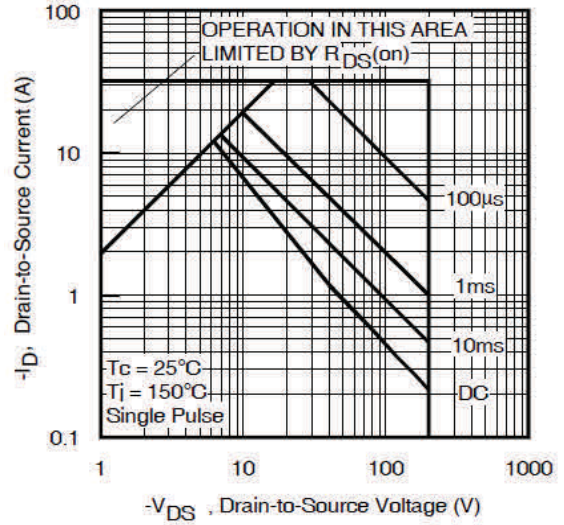

Fig 8. Maximum Safe Operating Area

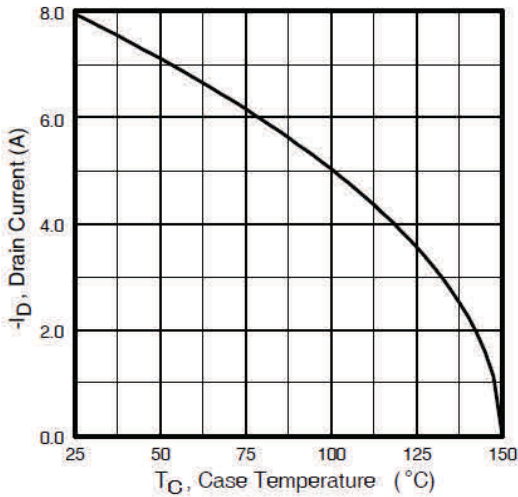

Fig 9. Maximum Drain Current Vs. Case Temperature

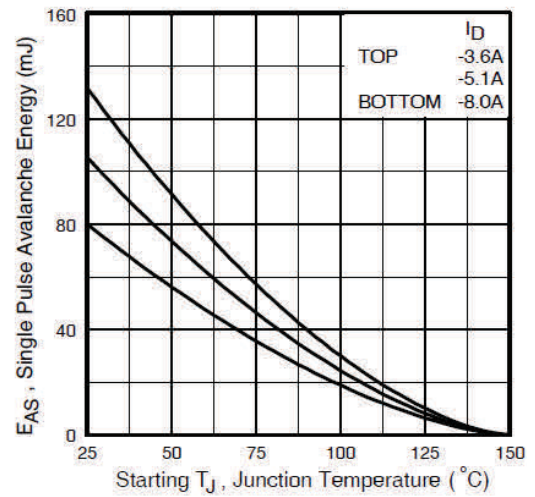

Fig 10. Maximum Avalanche Energy Vs. Drain Current

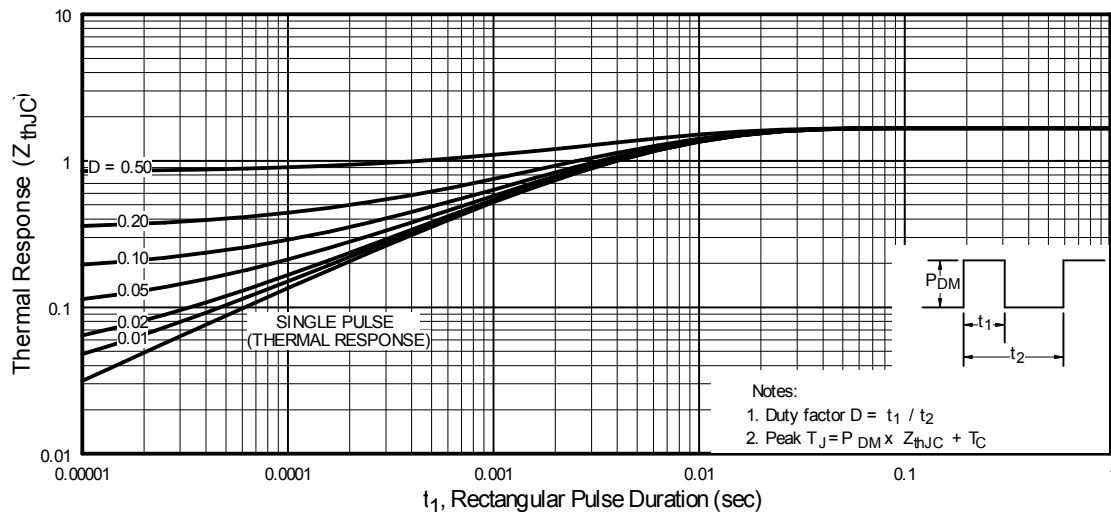

Fig 11. Maximum Effective Transient Thermal Impedance, Junction-to-Case

Pre-Irradiation

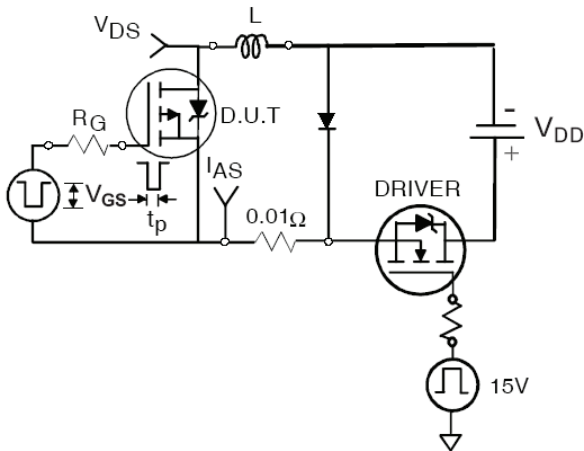

Fig 12a. Unclamped Inductive Test Circuit

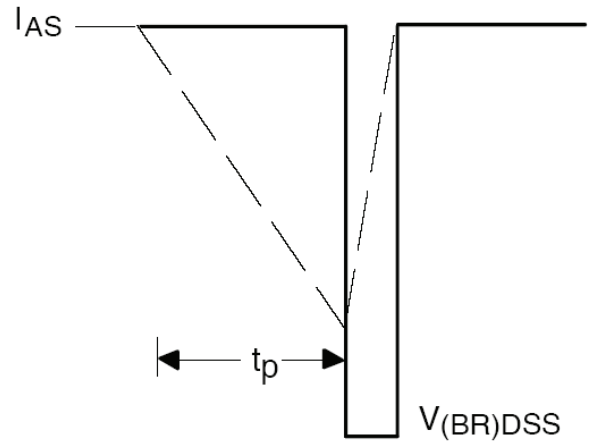

Fig 12b. Unclamped Inductive Waveforms

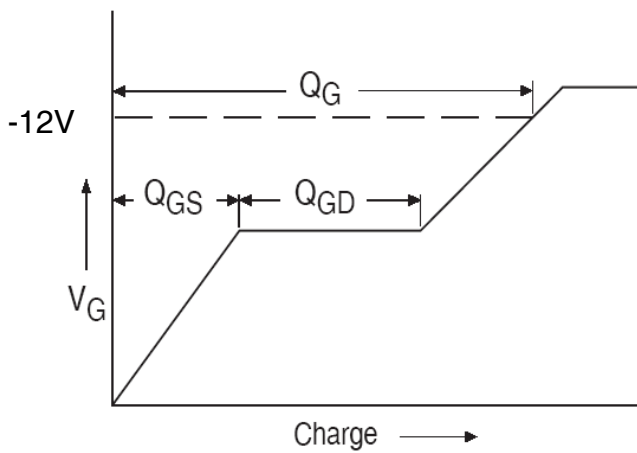

Fig 13a. Basic Gate Charge Waveform

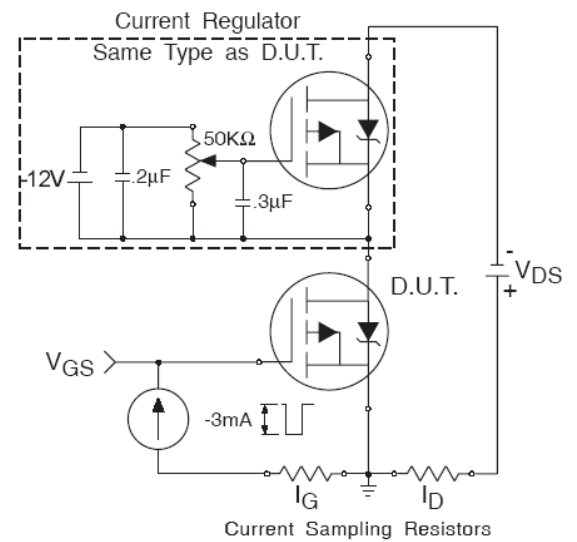

Fig 13b. Gate Charge Test Circuit

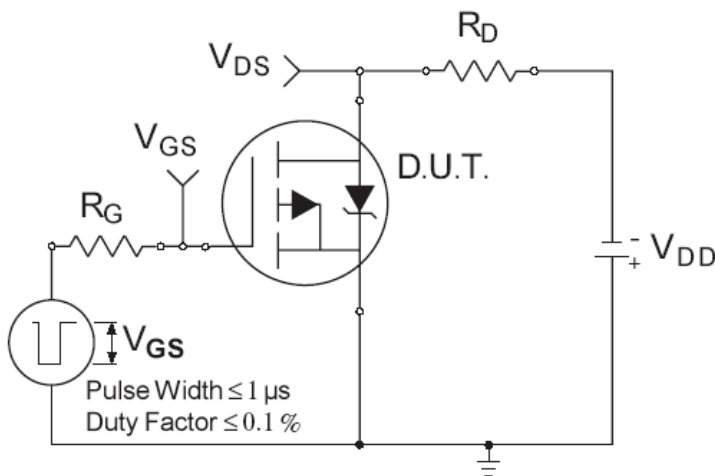

Fig 14a. Switching Time Test Circuit

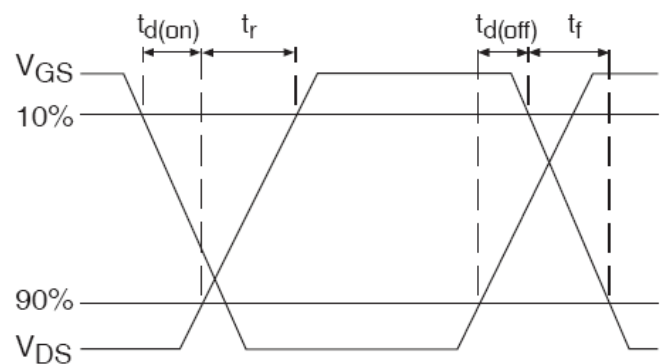
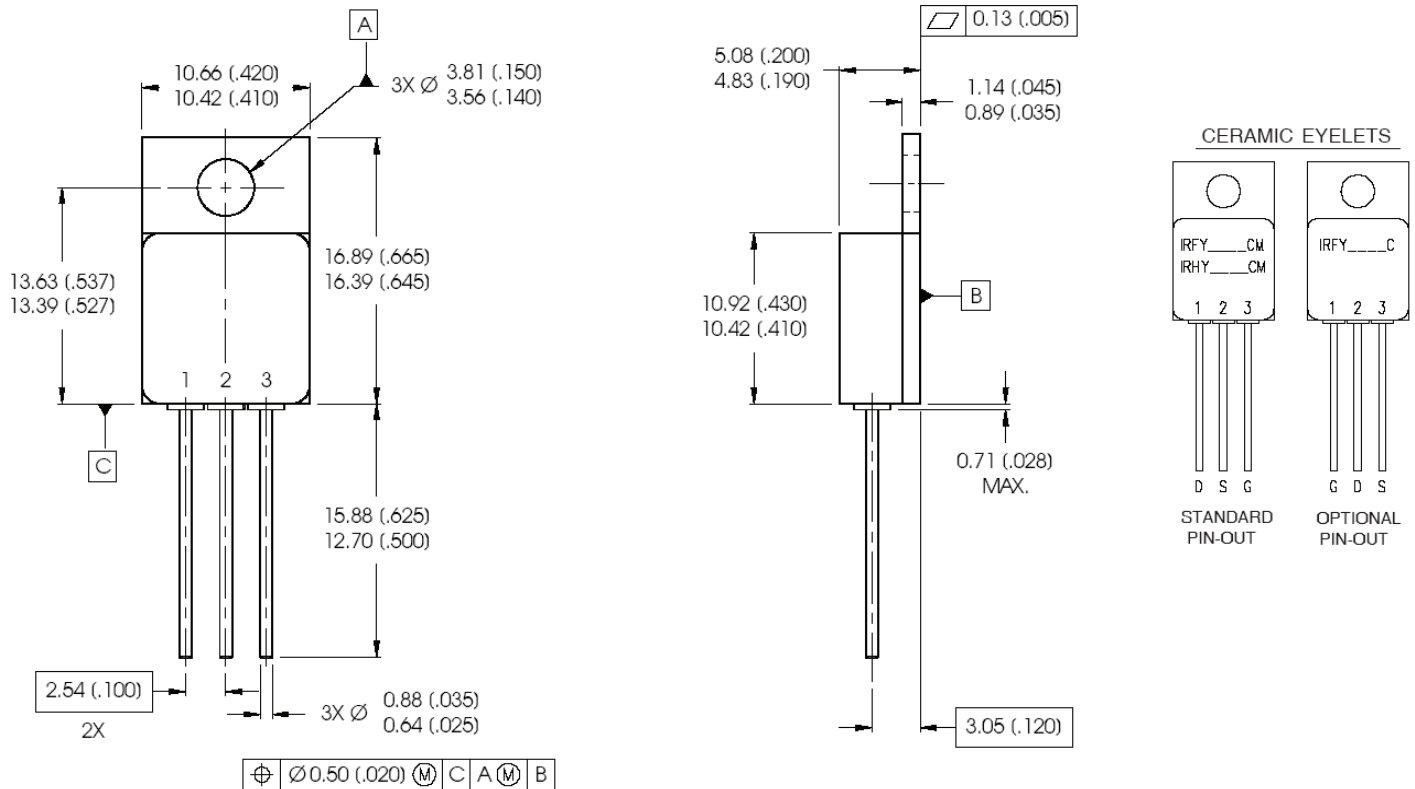

Fig 14b. Switching Time Waveforms

Case Outline and Dimensions - TO-257AA



NOTES:

1. DIMENSIONING & TOLERANCING PER ANSI Y14.5M-1994.
2. CONTROLLING DIMENSION: INCH.
3. DIMENSIONS ARE SHOWN IN MILLIMETERS (INCHES).
4. OUTLINE CONFORMS TO JEDEC OUTLINE TO-257AA

PIN ASSIGNMENTS

- 1 = DRAIN
- 2 = SOURCE
- 3 = GATE

BERYLLIA WARNING PER MIL-PRF-19500

Package containing beryllia shall not be ground, sandblasted, machined, or have other operations performed on them which will produce beryllia or beryllium dust. Furthermore, beryllium oxide packages shall not be placed in acids that will produce fumes containing beryllium.

IMPORTANT NOTICE

The information given in this document shall be in no event regarded as guarantee of conditions or characteristic. The data contained herein is a characterization of the component based on internal standards and is intended to demonstrate and provide guidance for typical part performance. It will require further evaluation, qualification and analysis to determine suitability in the application environment to confirm compliance to your system requirements.

With respect to any example hints or any typical values stated herein and/or any information regarding the application of the product, Infineon Technologies hereby disclaims any and all warranties and liabilities of any kind including without limitation warranties on non- infringement of intellectual property rights and any third party.

In addition, any information given in this document is subject to customer's compliance with its obligations stated in this document and any applicable legal requirements, norms and standards concerning customer's product and any use of the product of Infineon Technologies in customer's applications.

The data contained in this document is exclusively intended for technically trained staff. It is the responsibility of any customer's technical departments to evaluate the suitability of the product for the intended applications and the completeness of the product information given in this document with respect to applications.

For further information on the product, technology, delivery terms and conditions and prices, please contact your local sales representative or go to (www.infineon.com/hirel).

WARNING

Due to technical requirements products may contain dangerous substances. For information on the types in question, please contact your nearest Infineon Technologies office.