

# IRHNS9A7160 (JANSR2N7653U2A)

PD-97930C

## Radiation Hardened Power MOSFET Surface-Mount (SupIR-SMD™) 100V, 100A, N-channel, R9 Superjunction Technology

### Features

- Single event effect (SEE) hardened (up to LET of 89.8 MeV·cm<sup>2</sup>/mg)
- Low R<sub>DS(on)</sub>
- Fast switching
- Low total gate charge
- Simple drive requirements
- Hermetically sealed
- Ceramic package
- Direct-to-PCB attach
- Light weight
- ESD rating: class 3B per MIL-STD-750, Method 1020

### Potential Applications

- DC-DC converter
- Motor drives

### Product Validation

Qualified according to MIL-PRF-19500 for space applications

### Description

IR HiRel R9 technology provides superior power MOSFETs for space applications. These devices have improved immunity to Single Event Effect (SEE) and have been characterized for useful performance with Linear Energy Transfer (LET) up to 89.8 MeV·cm<sup>2</sup>/mg. Their combination of low R<sub>DS(on)</sub> and fast switching times will allow for better performance in applications such as DC-DC converters or motor drives. These devices retain all of the well established advantages of MOSFETs such as voltage control, fast switching and temperature stability of electrical parameters.

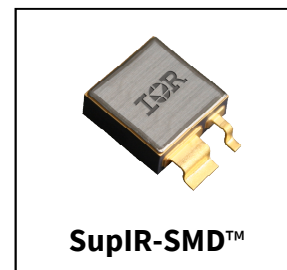
### Ordering Information

**Table 1** Ordering options

Part number	Package	Screening Level	TID Level
IRHNS9A7160	SupIR-SMD™	COTS	100krad(Si)
JANSR2N7653U2A	SupIR-SMD™	JANS	100krad(Si)
IRHNS9A3160	SupIR-SMD™	COTS	300krad(Si)
JANSF2N7653U2A	SupIR-SMD™	JANS	300krad(Si)

### Product Summary

- **Part number:** IRHNS9A7160 (JANSR2N7653U2A), IRHNS9A3160 (JANSF2N7653U2A)
- **REF:** MIL-PRF-19500/777
- **Radiation level:** 100 krad (Si), 300 krad (Si)
- **R<sub>DS(on), max</sub>:** 6.5mΩ
- **I<sub>D</sub>:** 100A\*



**Table of contents**

**Table of contents**

<b>Features .....</b>	<b>1</b>
<b>Potential Applications.....</b>	<b>1</b>
<b>Product Validation.....</b>	<b>1</b>
<b>Description .....</b>	<b>1</b>
<b>Ordering Information.....</b>	<b>1</b>
<b>Table of contents.....</b>	<b>2</b>
<b>1 Absolute Maximum Ratings .....</b>	<b>3</b>
<b>2 Device Characteristics .....</b>	<b>4</b>
2.1 Electrical Characteristics (Pre-Irradiation).....	4
2.2 Source-Drain Diode Ratings and Characteristics (Pre-Irradiation) .....	5
2.3 Thermal Characteristics .....	5
2.4 Radiation Characteristics.....	5
2.4.1 Electrical Characteristics - Post Total Dose Irradiation .....	5
2.4.2 Single Event Effects – Safe Operating Area .....	6
<b>3 Electrical Characteristics Curves (Pre-irradiation) .....</b>	<b>7</b>
<b>4 Test Circuits (Pre-irradiation) .....</b>	<b>11</b>
<b>5 Package Outline .....</b>	<b>12</b>
<b>Revision history.....</b>	<b>13</b>

**Absolute Maximum Ratings**

**1 Absolute Maximum Ratings**

**Table 2 Absolute Maximum Ratings (Pre-Irradiation)**

Symbol	Parameter	Value	Unit
$I_{D1} @ V_{GS} = 12V, T_C = 25^\circ C$	Continuous Drain Current	100*	A
$I_{D2} @ V_{GS} = 12V, T_C = 100^\circ C$	Continuous Drain Current	93	A
$I_{DM} @ T_C = 25^\circ C$	Pulsed Drain Current <sup>1</sup>	400	A
$P_D @ T_C = 25^\circ C$	Maximum Power Dissipation	250	W
	Linear Derating Factor	2.0	W/°C
$V_{GS}$	Gate-to-Source Voltage	± 20	V
$E_{AS}$	Single Pulse Avalanche Energy <sup>2</sup>	3027	mJ
$I_{AR}$	Avalanche Current <sup>1</sup>	93	A
$E_{AR}$	Repetitive Avalanche Energy <sup>1</sup>	25	mJ
dv/dt	Peak Diode Reverse Recovery <sup>3</sup>	24	V/ns
$T_J$ $T_{STG}$	Operating Junction and Storage Temperature Range	-55 to +150	°C
	Lead Temperature	300 (for 5s)	
	Weight	3.3 (Typical)	

\* Current is limited by package

<sup>1</sup> Repetitive Rating; Pulse width limited by maximum junction temperature.

<sup>2</sup>  $V_{DD} = 100V$ , starting  $T_J = 25^\circ C$ ,  $L = 0.7mH$ , Peak  $I_L = 93A$ ,  $V_{GS} = 20V$

<sup>3</sup>  $I_{SD} \leq 93A$ ,  $di/dt \leq 2190A/\mu s$ ,  $V_{DD} \leq 100V$ ,  $T_J \leq 150^\circ C$

**Device Characteristics**

**2 Device Characteristics**

**2.1 Electrical Characteristics (Pre-Irradiation)**

**Table 3 Static and Dynamic Electrical Characteristics @  $T_j = 25^\circ\text{C}$  (Unless Otherwise Specified)**

Symbol	Parameter	Min.	Typ.	Max.	Unit	Test Conditions
$BV_{DSS}$	Drain-to-Source Breakdown Voltage	100	—	—	V	$V_{GS} = 0V, I_D = 1.0mA$
$\Delta BV_{DSS}/\Delta T_J$	Breakdown Voltage Temp. Coefficient	—	0.10	—	V/°C	Reference to $25^\circ\text{C}$ , $I_D = 1.0mA$
$R_{DS(on)}$	Static Drain-to-Source On-State Resistance	—	—	6.5	mΩ	$V_{GS} = 12V, I_{D2} = 93A^1$
$V_{GS(th)}$	Gate Threshold Voltage	2.0	—	4.0	V	$V_{DS} \geq V_{GS}, I_D = 6.0mA$
$\Delta V_{GS(th)}/\Delta T_J$	Gate Threshold Voltage Coefficient	—	-8.1	—	mV/°C	
Gfs	Forward Transconductance	68	—	—	S	$V_{DS} = 15V, I_{D2} = 93A^1$
$I_{DSS}$	Zero Gate Voltage Drain Current	—	—	1.0	μA	$V_{DS} = 80V, V_{GS} = 0V$
		—	—	25		$V_{DS} = 80V, V_{GS} = 0V, T_J = 125^\circ\text{C}$
$I_{GSS}$	Gate-to-Source Leakage Forward	—	—	100	nA	$V_{GS} = 20V$
	Gate-to-Source Leakage Reverse	—	—	-100		$V_{GS} = -20V$
$Q_G$	Total Gate Charge	—	—	195	nC	$I_{D1} = 100A$
$Q_{GS}$	Gate-to-Source Charge	—	—	67		$V_{DS} = 50V$
$Q_{GD}$	Gate-to-Drain ('Miller') Charge	—	—	52		$V_{GS} = 12V$
$t_{d(on)}$	Turn-On Delay Time	—	—	41	ns	$I_{D1} = 100A^{**}$ $V_{DD} = 50V$ $R_G = 2.4\Omega$ $V_{GS} = 12V$
$t_r$	Rise Time	—	—	101		
$t_{d(off)}$	Turn-Off Delay Time	—	—	98		
$t_f$	Fall Time	—	—	28		
$L_s + L_D$	Total Inductance	—	4.0	—	nH	Measured from center of Drain pad to center of Source pad
$C_{iss}$	Input Capacitance	—	9808	—	pF	$V_{GS} = 0V$
$C_{oss}$	Output Capacitance	—	2407	—		$V_{DS} = 25V$
$C_{rss}$	Reverse Transfer Capacitance	—	15	—		$f = 100KHz$
$R_G$	Gate Resistance	—	1.1	—	Ω	$f = 1.0MHz$ , open drain

\*\* Switching speed maximum limits are based on manufacturing test equipment and capability.

<sup>1</sup> Pulse width ≤ 300 μs; Duty Cycle ≤ 2%

**Device Characteristics**

**2.2 Source-Drain Diode Ratings and Characteristics (Pre-Irradiation)**

**Table 4 Source-Drain Diode Characteristics**

Symbol	Parameter	Min.	Typ.	Max.	Unit	Test Conditions
$I_S$	Continuous Source Current (Body Diode)	—	—	100	A	
$I_{SM}$	Pulsed Source Current (Body Diode) <sup>1</sup>	—	—	400	A	
$V_{SD}$	Diode Forward Voltage	—	—	1.2	V	$T_J = 25^\circ\text{C}$ , $I_S = 100\text{A}$ , $V_{GS} = 0\text{V}$ <sup>2</sup>
$t_{rr}$	Reverse Recovery Time	—	168	252	ns	$T_J = 25^\circ\text{C}$ , $I_F = 100\text{A}$ , $V_{DD} \leq 25\text{V}$ $di/dt = -100\text{A}/\mu\text{s}$ <sup>2</sup>
$Q_{rr}$	Reverse Recovery Charge	—	1331	—	nC	
$t_{on}$	Forward Turn-On Time	Intrinsic turn-on time is negligible (turn-on is dominated by $L_S+L_D$ )				

**2.3 Thermal Characteristics**

**Table 5 Thermal Resistance**

Symbol	Parameter	Min.	Typ.	Max.	Unit
$R_{\theta JC}$	Junction-to-Case	—	—	0.50	$^\circ\text{C}/\text{W}$
$R_{\theta J-PCB}$	Junction-to-PC Board (Soldered to 2" sq.inch copper clad board)	—	1.6	—	

**2.4 Radiation Characteristics**

IR HiRel radiation hardened MOSFETs are tested to verify their radiation hardness capability. The hardness assurance program at IR HiRel is comprised of two radiation environments. Every manufacturing lot is tested for total ionizing dose (per notes 3 and 4) using the TO-3 package. Both pre- and post-irradiation performance are tested and specified using the same drive circuitry and test conditions in order to provide a direct comparison.

**2.4.1 Electrical Characteristics - Post Total Dose Irradiation**

**Table 6 Electrical Characteristics @  $T_J = 25^\circ\text{C}$ , Post Total Dose Irradiation<sup>3, 4</sup>**

Symbol	Parameter	Up to 300krads (Si) <sup>5</sup>		Unit	Test Conditions
		Min.	Max.		
$BV_{DSS}$	Drain-to-Source Breakdown Voltage	100	—	V	$V_{GS} = 0\text{V}$ , $I_D = 1\text{mA}$
$V_{GS(th)}$	Gate Threshold Voltage	2.0	4.0	V	$V_{DS} \geq V_{GS}$ , $I_D = 6.0\text{mA}$
$I_{GSS}$	Gate-to-Source Leakage Forward	—	100	nA	$V_{GS} = 20\text{V}$
	Gate-to-Source Leakage Reverse	—	-100		$V_{GS} = -20\text{V}$
$I_{DSS}$	Zero Gate Voltage Drain Current	—	1.0	$\mu\text{A}$	$V_{DS} = 80\text{V}$ , $V_{GS} = 0\text{V}$
$R_{DS(on)}$	Static Drain-to-Source On-State Resistance (TO-3) <sup>2</sup>	—	8.0	$\text{m}\Omega$	$V_{GS} = 12\text{V}$ , $I_{D2} = 75\text{A}$
$R_{DS(on)}$	Static Drain-to-Source On-State Resistance (SupIR-SMD) <sup>2</sup>	—	6.5	$\text{m}\Omega$	$V_{GS} = 12\text{V}$ , $I_{D2} = 93\text{A}$
$V_{SD}$	Diode Forward Voltage	—	1.2	V	$V_{GS} = 0\text{V}$ , $I_F = 75\text{A}$

<sup>1</sup> Repetitive Rating; Pulse width limited by maximum junction temperature.

<sup>2</sup> Pulse width  $\leq 300 \mu\text{s}$ ; Duty Cycle  $\leq 2\%$

<sup>3</sup> Total Dose Irradiation with  $V_{GS}$  Bias.  $V_{GS} = 12\text{V}$  applied and  $V_{DS} = 0$  during irradiation per MIL-STD-750, Method 1019, condition A.

<sup>4</sup> Total Dose Irradiation with  $V_{DS}$  Bias.  $V_{DS} = 80\text{V}$  applied and  $V_{GS} = 0$  during irradiation per MIL-STD-750, Method 1019, condition A.

<sup>5</sup> Part numbers IRHNS9A7160 (JANSR2N7653U2A) and IRHNS9A3160 (JANSF2N7653U2A)

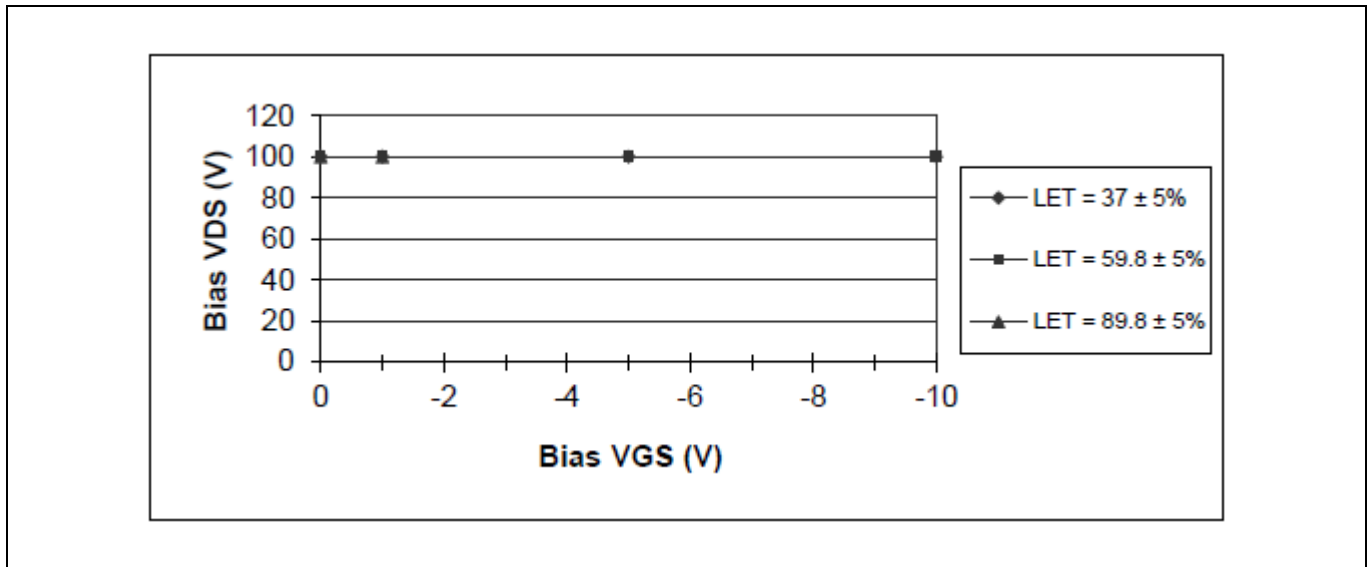
**Device Characteristics**

**2.4.2 Single Event Effects – Safe Operating Area**

IR HiRel radiation hardened MOSFETs have been characterized in heavy ion environment for Single Event Effects (SEE). Single Event Effects characterization is illustrated in Fig. 1 and Table 7.

**Table 7 Typical Single Event Effects Safe Operating Area**

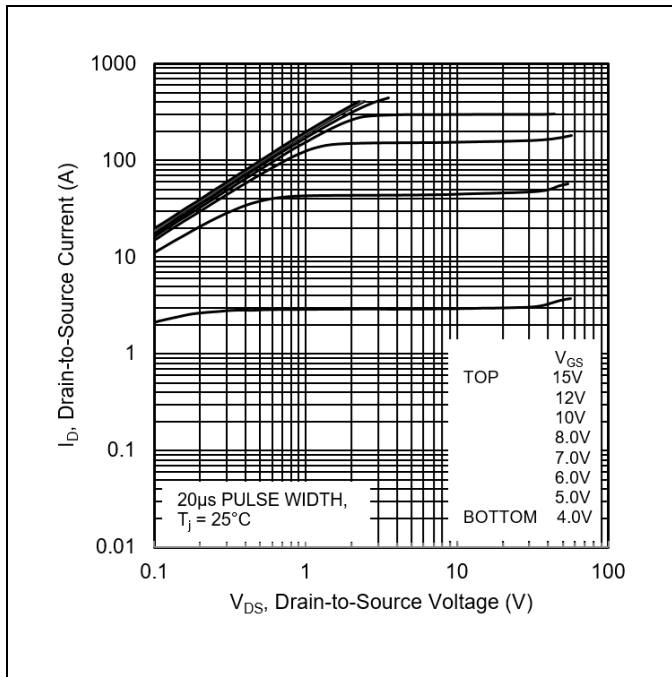
LET (MeV·cm <sup>2</sup> /mg)	Energy (MeV)	Range (μm)	V <sub>DS</sub> (V)			
			V <sub>GS</sub> = 0V	V <sub>GS</sub> = -1V	V <sub>GS</sub> = -5V	V <sub>GS</sub> = -10V
37 ± 5%	417 ± 7.5%	50 ± 7.5%	100	100	100	100
59.8 ± 5%	753 ± 7.5%	60 ± 7.5%	100	100	100	100
89.8 ± 5%	1515 ± 7.5%	82 ± 7.5%	100	100	—	—



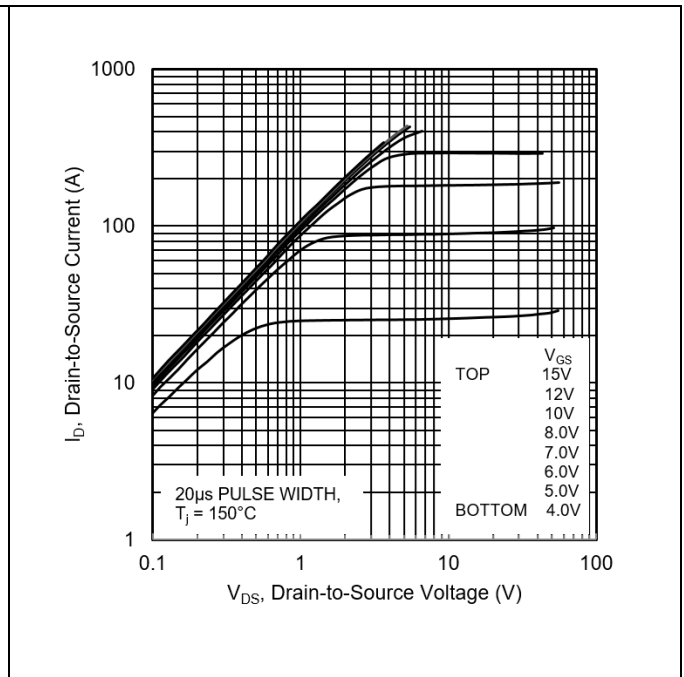
**Figure 1 Typical Single Event Effect, Safe Operating Area**

**Electrical Characteristics Curves (Pre-irradiation)**

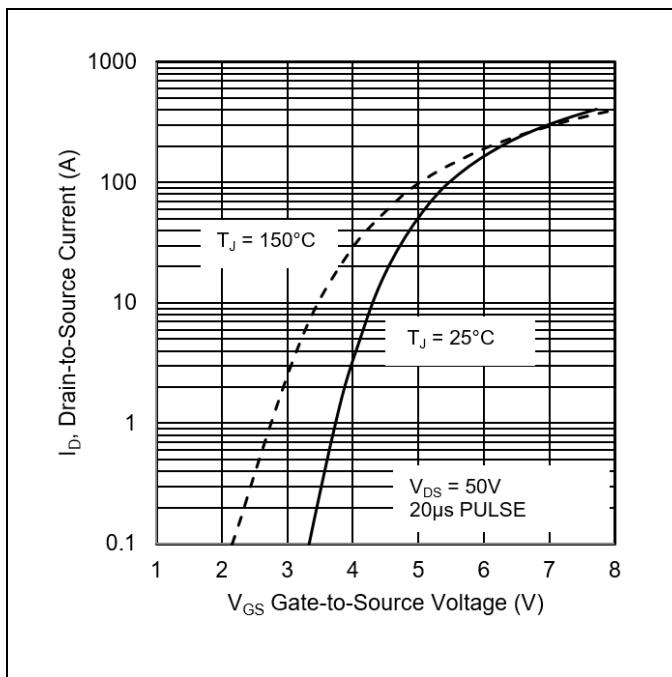
**3 Electrical Characteristics Curves (Pre-irradiation)**



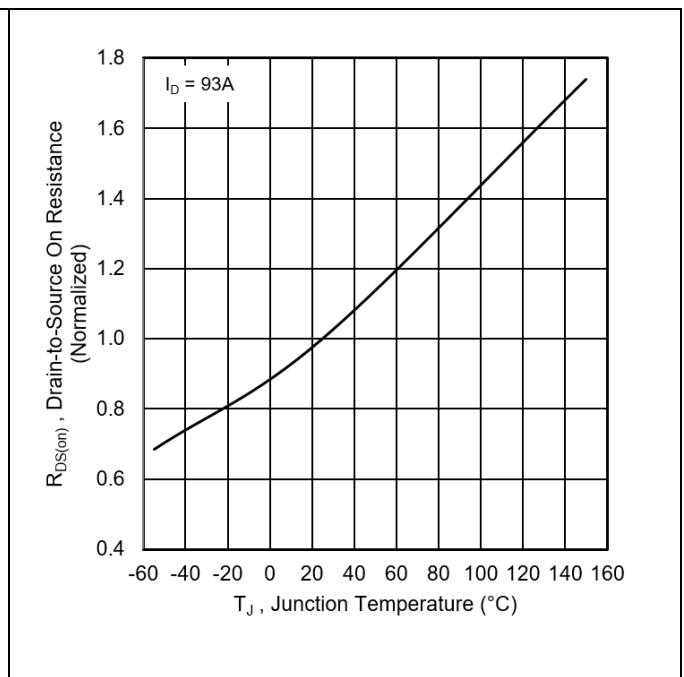
**Figure 2 Typical Output Characteristics**



**Figure 3 Typical Output Characteristics**

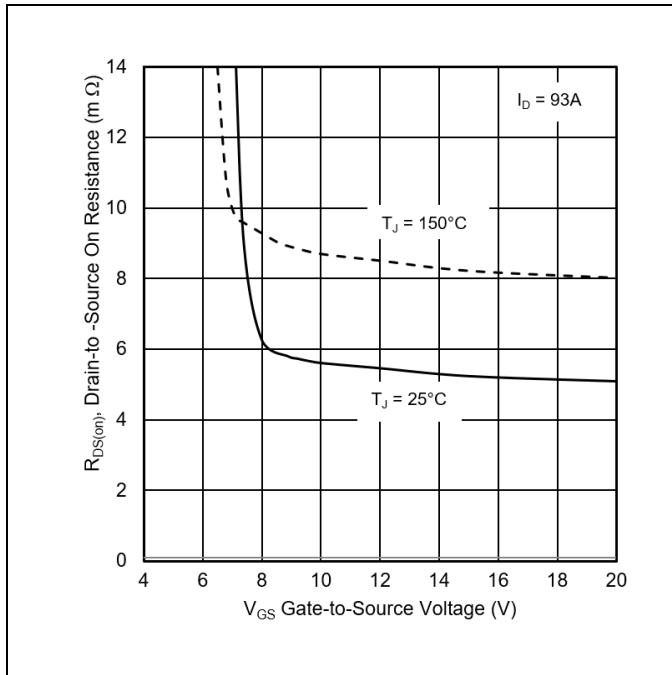


**Figure 4 Typical Transfer Characteristics**

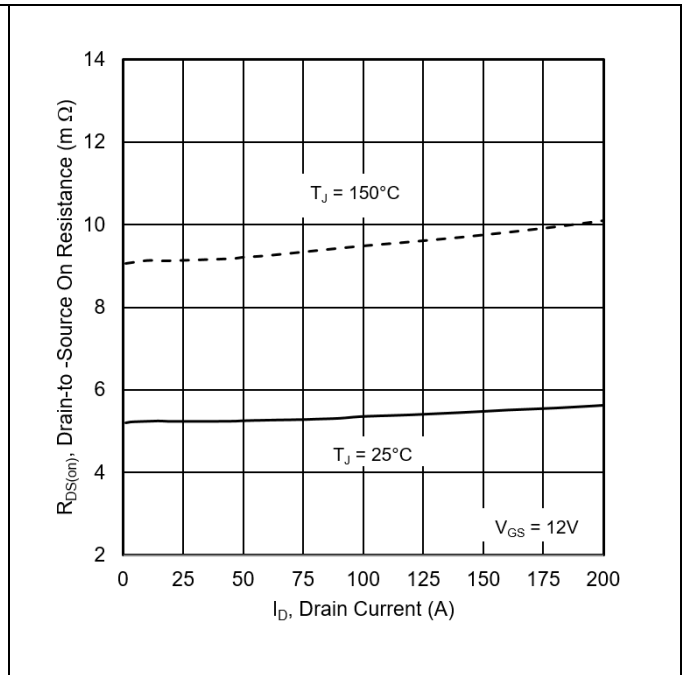


**Figure 5 Normalized On-Resistance Vs. Temperature**

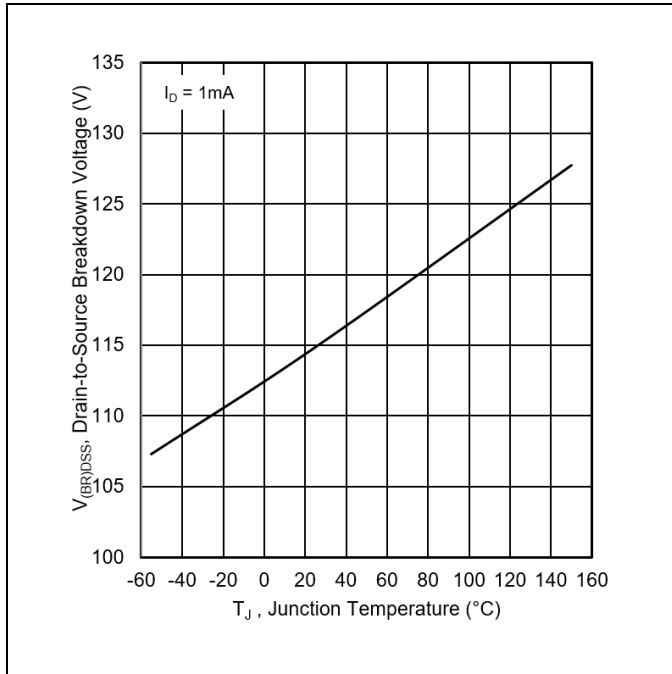
**Electrical Characteristics Curves (Pre-irradiation)**



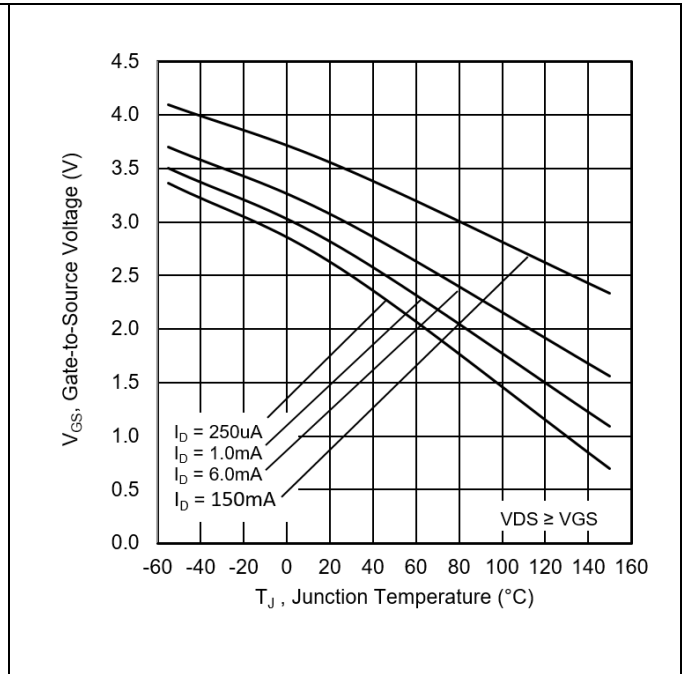
**Figure 6 Typical On-Resistance Vs. Gate Voltage**



**Figure 7 Typical On-Resistance Vs. Drain Current**



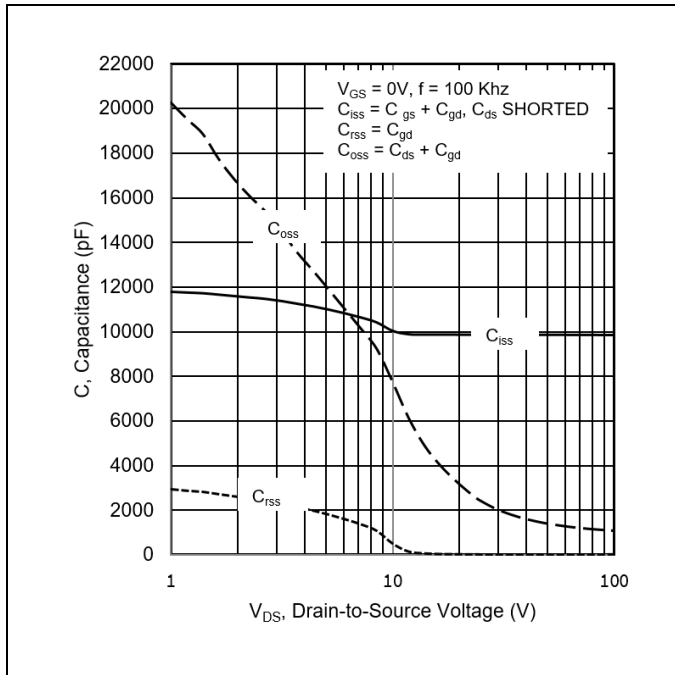
**Figure 8 Typical Drain-to-Source Breakdown Voltage Vs. Temperature**



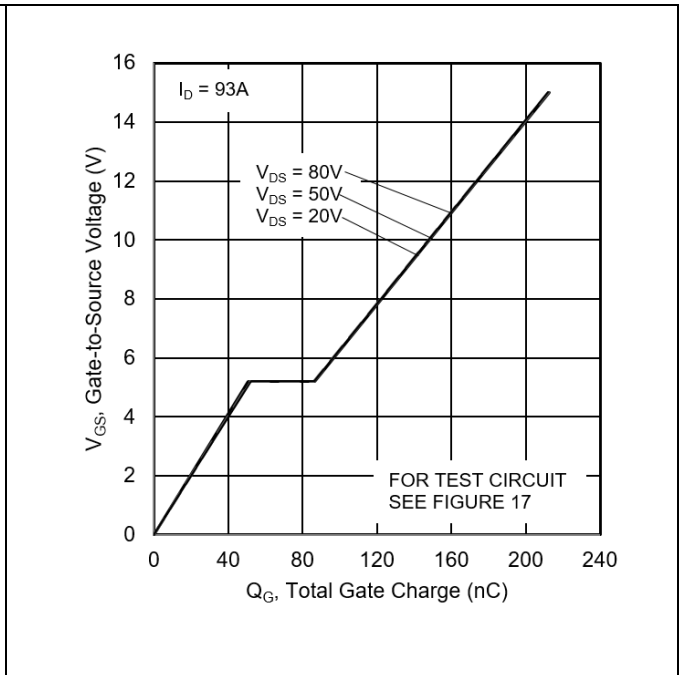
**Figure 9 Typical Threshold Voltage Vs. Temperature**



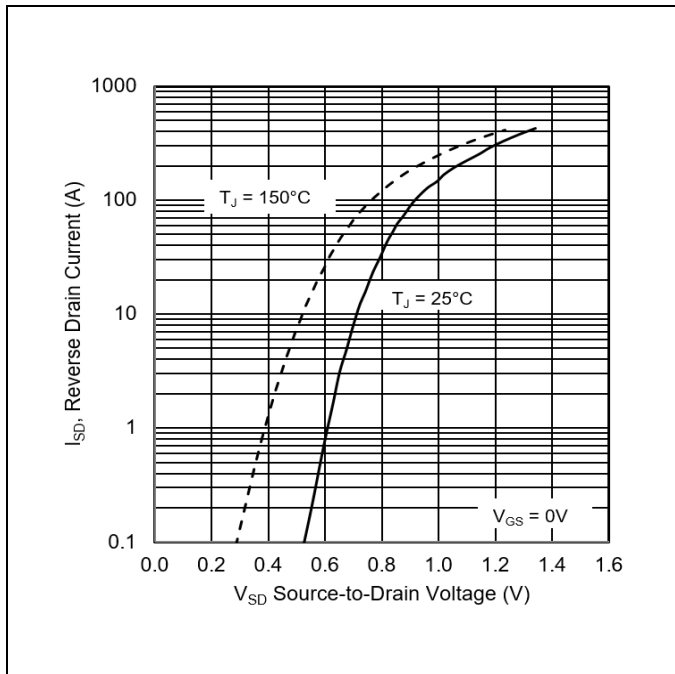
**IRHNS9A7160 (JANSR2N7653U2A)**  
**Radiation Hardened Power MOSFET (SupIR-SMD™)**  
**Electrical Characteristics Curves (Pre-irradiation)**



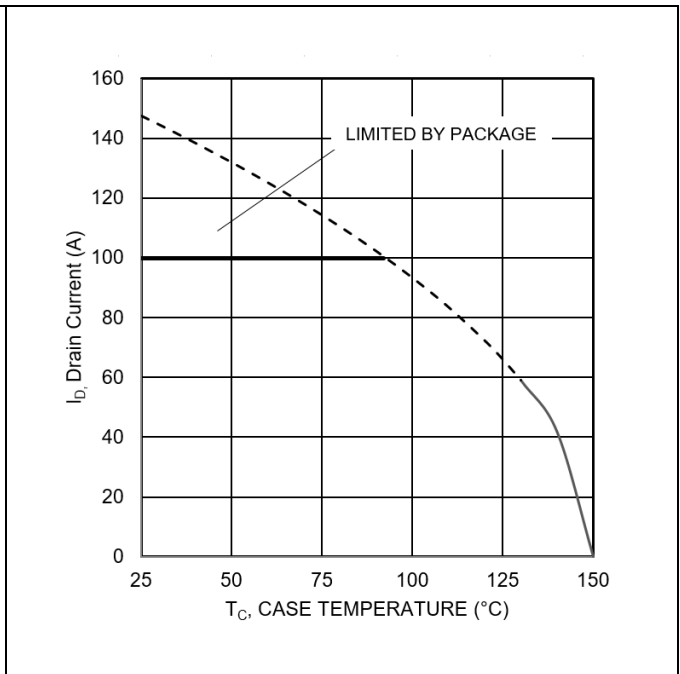
**Figure 10 Typical Capacitance Vs. Drain-to-Source Voltage**



**Figure 11 Typical Gate-to-Source Voltage Vs. Gate Charge**



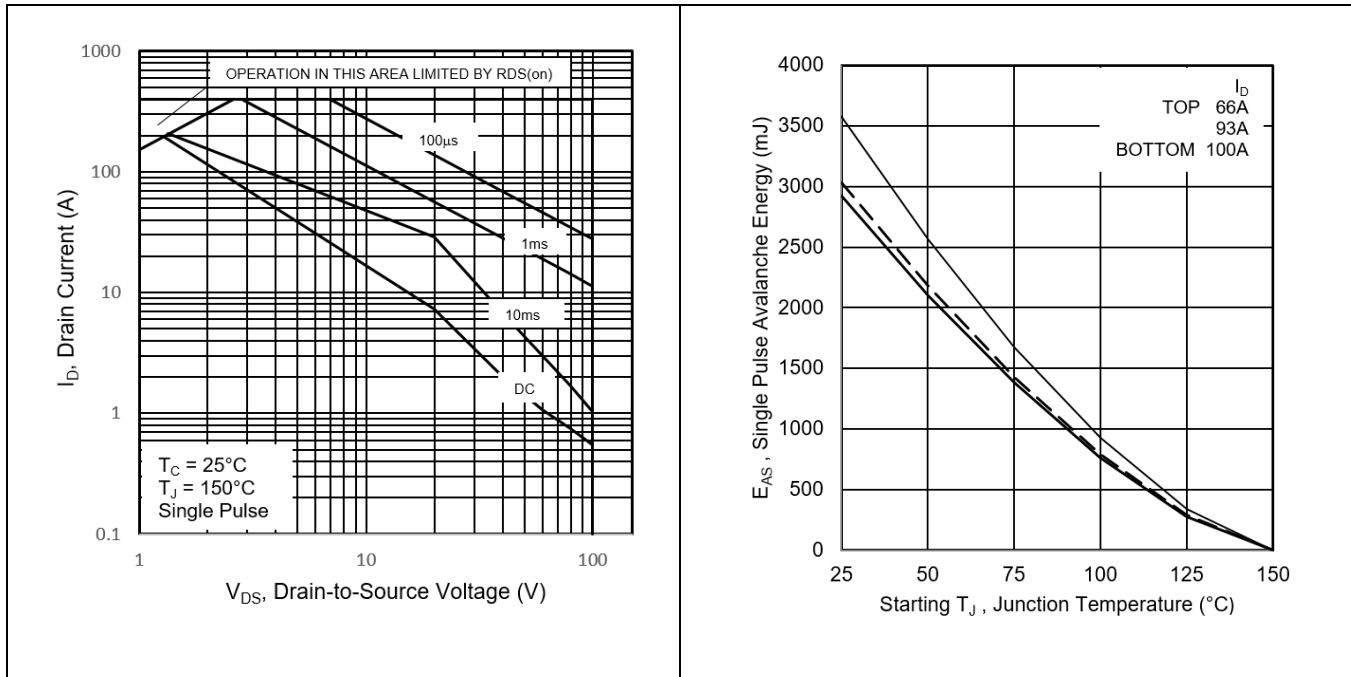
**Figure 12 Typical Source-Drain Vs. Diode Forward Voltage**



**Figure 13 Maximum Drain Current Vs. Case Temperature**

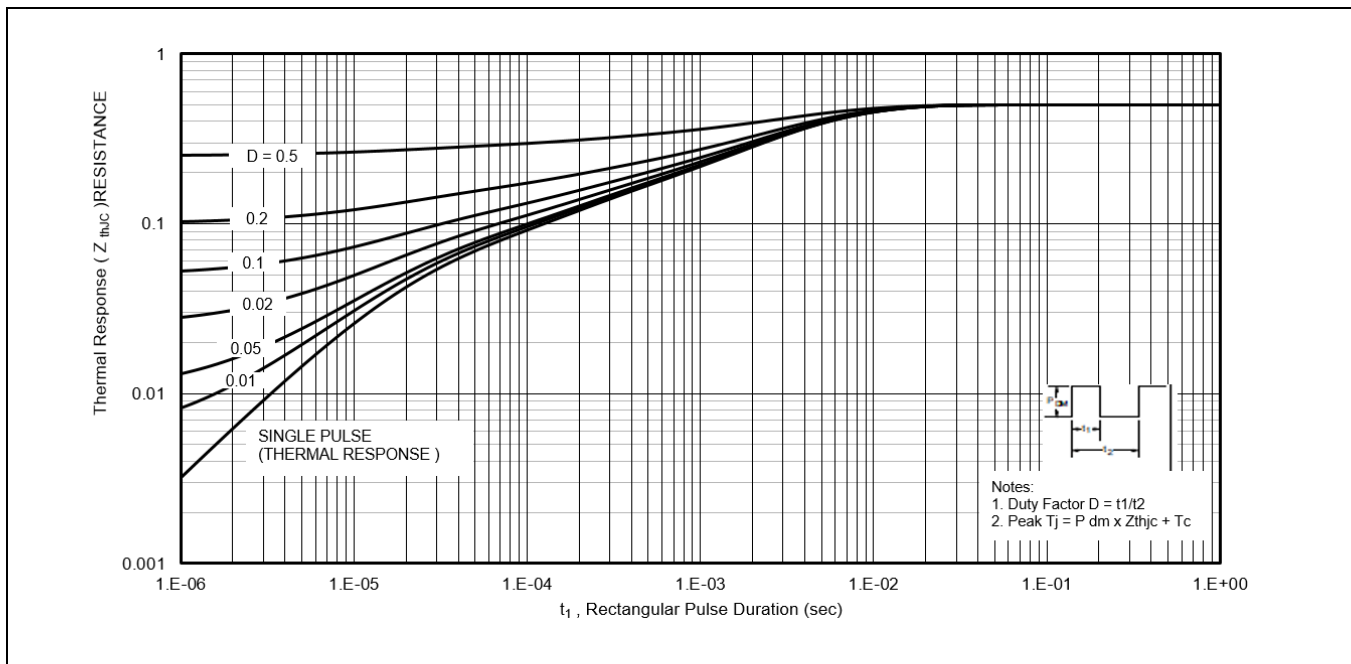
**IRHNS9A7160 (JANSR2N7653U2A)**  
**Radiation Hardened Power MOSFET (SupIR-SMD™)**

**Electrical Characteristics Curves (Pre-irradiation)**



**Figure 14** Maximum Safe Operating Area

**Figure 15** Maximum Avalanche Energy Vs. Drain Current

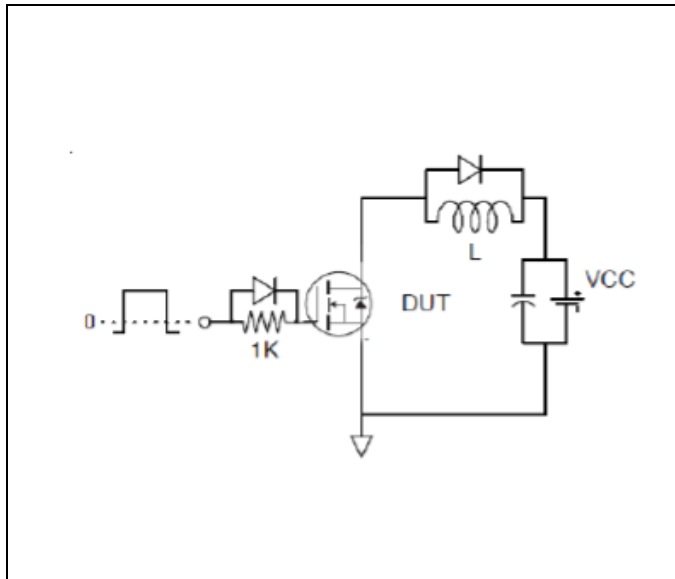


**Figure 16** Maximum Effective Transient Thermal Impedance, Junction-to-Case

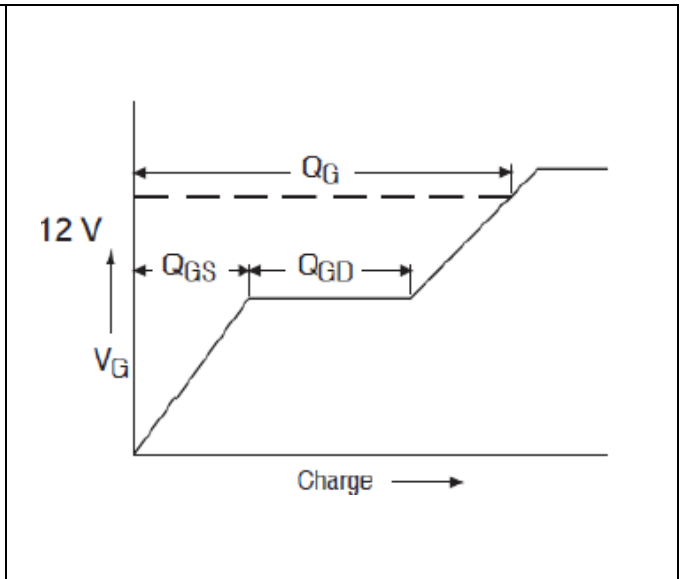
**IRHNS9A7160 (JANSR2N7653U2A)**  
**Radiation Hardened Power MOSFET (SupIR-SMD™)**

**Test Circuits (Pre-irradiation)**

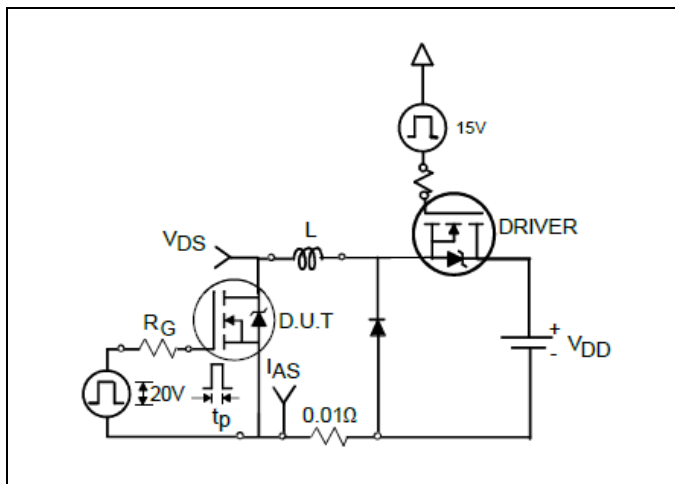
**4 Test Circuits (Pre-irradiation)**



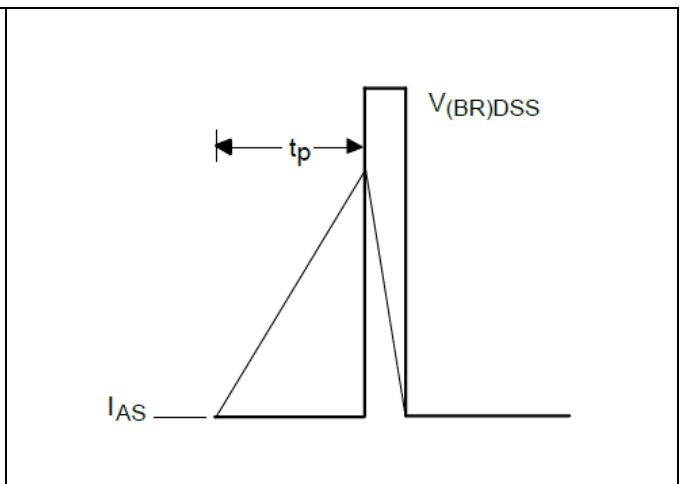
**Figure 17 Gate Charge Test Circuit**



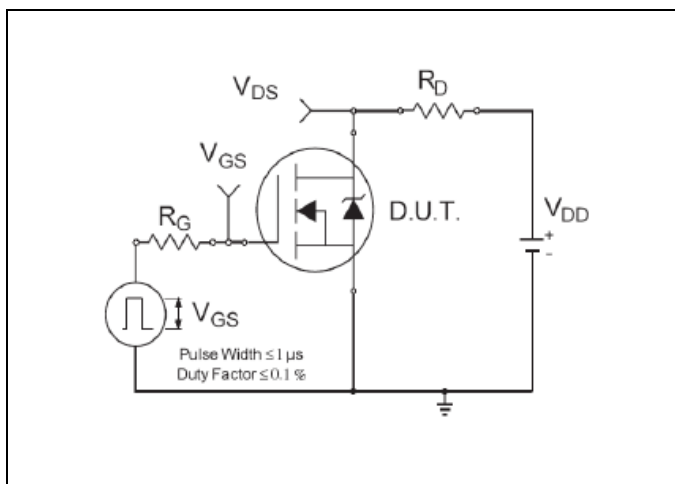
**Figure 18 Gate Charge Waveform**



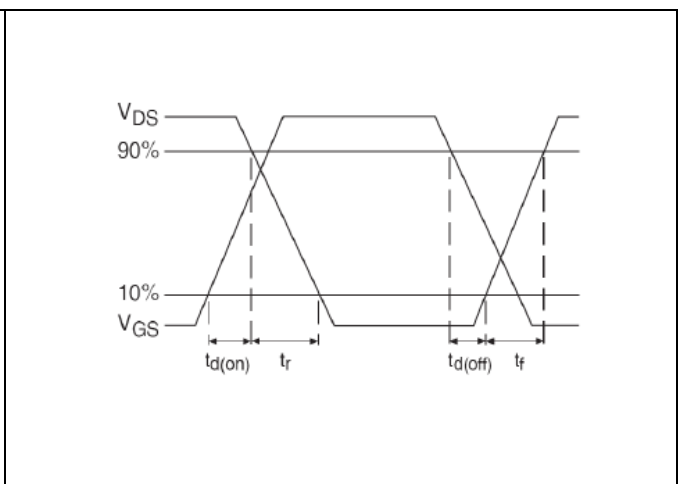
**Figure 19 Unclamped Inductive Test Circuit**



**Figure 20 Unclamped Inductive Waveform**



**Figure 21 Switching Time Test Circuit**



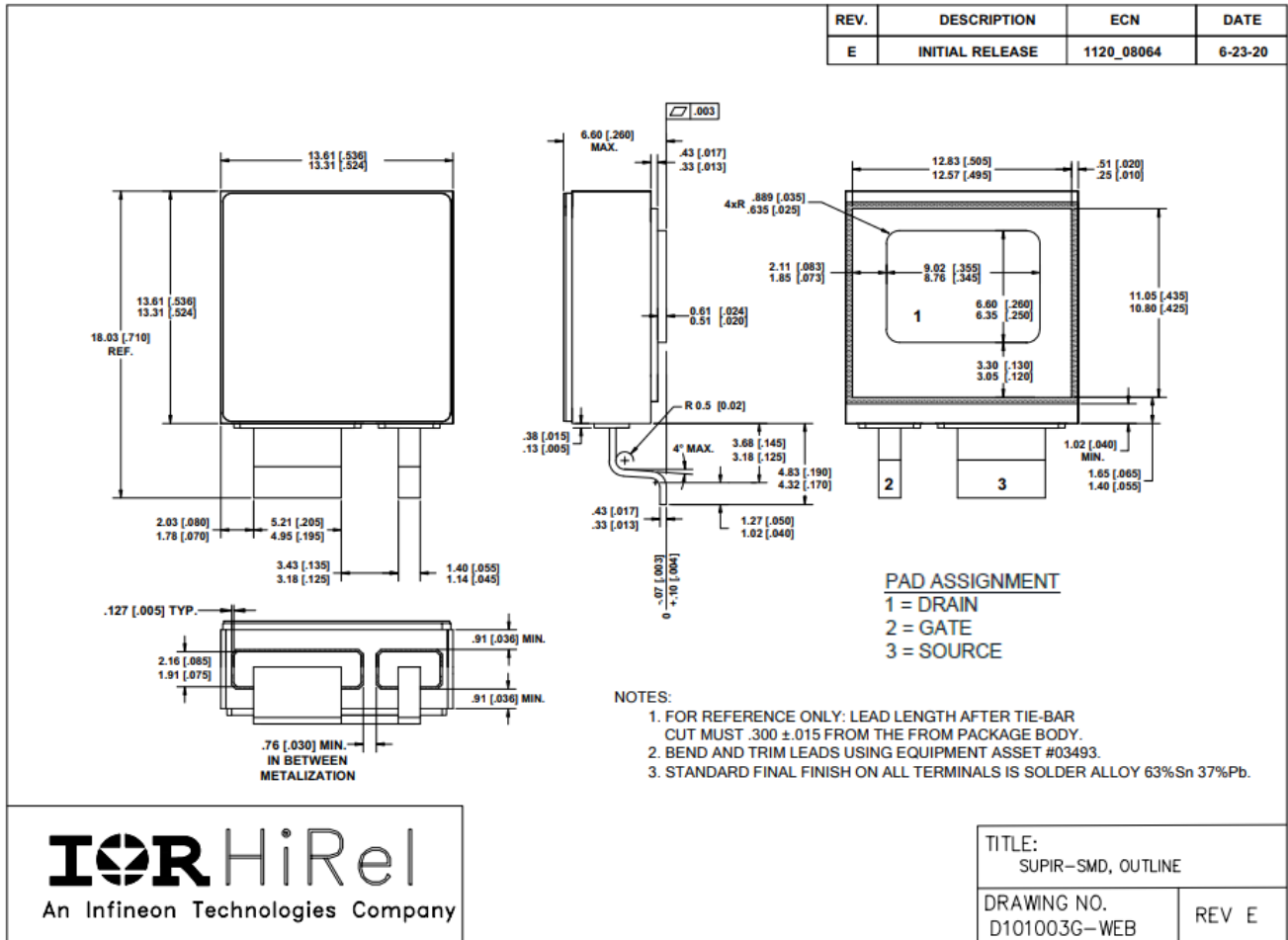
**Figure 22 Switching Time Waveforms**

**IRHNS9A7160 (JANSR2N7653U2A)**  
**Radiation Hardened Power MOSFET (SupIR-SMD™)**

**Package Outline**

**5 Package Outline**

**Note:** For the most updated package outline, please see the website: [SupIR-SMD](#)



# IRHNS9A7160 (JANSR2N7653U2A)

## Radiation Hardened Power MOSFET (SupIR-SMD™)

### Revision history

### Revision history

Document version	Date of release	Description of changes
	09/22/2021	Preliminary datasheet with PPD number (PPD-97930A)
Rev B	09/27/2021	Final datasheet with PD number
Rev C	01/21/2022	Updated based on ECN-1120_8889

## Trademarks

All referenced product or service names and trademarks are the property of their respective owners.

**Edition 2022-01-21**

### Published by

**International Rectifier HiRel Products,  
Inc.**

**An Infineon Technologies company  
El Segundo, California 90245 USA**

**© 2022 Infineon Technologies AG.  
All Rights Reserved.**

**Do you have a question about this  
document?**

**Email: [erratum@infineon.com](mailto:erratum@infineon.com)**

**Document reference**

## IMPORTANT NOTICE

The information given in this document shall in no event be regarded as a guarantee of conditions or characteristics ("Beschaffheitsgarantie").

With respect to any examples, hints or any typical values stated herein and/or any information regarding the application of the product, Infineon Technologies hereby disclaims any and all warranties and liabilities of any kind, including without limitation warranties of non-infringement of intellectual property rights of any third party.

In addition, any information given in this document is subject to customer's compliance with its obligations stated in this document and any applicable legal requirements, norms and standards concerning customer's products and any use of the product of Infineon Technologies in customer's applications.

The data contained in this document is exclusively intended for technically trained staff. It is the responsibility of customer's technical departments to evaluate the suitability of the product for the intended application and the completeness of the product information given in this document with respect to such application.

For further information on the product, technology, delivery terms and conditions and prices please contact your nearest Infineon Technologies office ([www.infineon.com](http://www.infineon.com)).

## WARNINGS

Due to technical requirements components may contain dangerous substances. For information on the types in question please contact your nearest International Rectifier HiRel Products, Inc., an Infineon Technologies company, office.

International Rectifier HiRel Components may only be used in life-support devices or systems with the expressed written approval of International Rectifier HiRel Products, Inc., an Infineon Technologies company, if failure of such components can reasonably be expected to cause the failure of that life-support device or system, or to affect the safety and effectiveness of that device or system.

Technologies, Infineon Technologies' products may not be used in any applications where a failure of the product or any consequences of the use thereof can reasonably be expected to result in personal injury.

Life support devices or systems are intended to be implanted in the human body, or to support and/or maintain and sustain and/or protect human life. If they fail, it is reasonable to assume that the health of the user or other persons may be endangered.