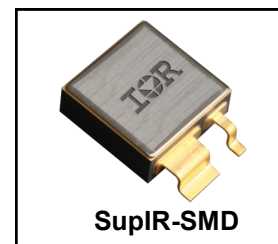


**RADIATION HARDENED  
POWER MOSFET  
SURFACE MOUNT (SupIR-SMD)**

**200V, P-CHANNEL**  
**REF: MIL-PRF-19500/713**  
**R<sub>5</sub> TECHNOLOGY**

**Product Summary**

| Part Number | Radiation Level | RDS(on) | I <sub>D</sub> | QPL Part Number |
|-------------|-----------------|---------|----------------|-----------------|
| IRHNS597260 | 100 kRads(Si)   | 0.102Ω  | -33.5A         | JANSR2N7549U2A  |
| IRHNS593260 | 300 kRads(Si)   | 0.102Ω  | -33.5A         | JANSF2N7549U2A  |



**Description**

IR HiRel R5 technology provides high performance power MOSFETs for space applications. These devices have been characterized for both Total Dose and Single Event Effect (SEE) with useful performance up to LET of 80 (MeV/(mg/cm<sup>2</sup>)). The combination of low RDS(on) and low gate charge reduces the power losses in switching applications such as DC-DC converters and motor controllers. These devices retain all of the well established advantages of MOSFETs such as voltage control, fast switching and temperature stability of electrical parameters.

**Features**

- Single Event Effect (SEE) Hardened
- Low RDS(on)
- Low Total Gate Charge
- Simple Drive Requirements
- Hermetically Sealed
- Ceramic Package
- Light Weight
- Surface Mount
- ESD Rating: Class 3A per MIL-STD-750, Method 1020

**Absolute Maximum Ratings**

**Pre-Irradiation**

| Symbol   | Parameter   | Value         | Units |
|--|---|---------------|-------|
| I <sub>D1</sub> @ V <sub>GS</sub> = -12V, T <sub>C</sub> = 25°C  | Continuous Drain Current                            | -33.5         | A     |
| I <sub>D2</sub> @ V <sub>GS</sub> = -12V, T <sub>C</sub> = 100°C | Continuous Drain Current                            | -21           |       |
| I <sub>DM</sub> @ T <sub>C</sub> = 25°C                          | Pulsed Drain Current ①                              | -134          |       |
| P <sub>D</sub> @ T <sub>C</sub> = 25°C                           | Maximum Power Dissipation                           | 250           | W     |
|  | Linear Derating Factor                              | 2.0           | W/°C  |
| V <sub>GS</sub>  | Gate-to-Source Voltage                              | ± 20          | V     |
| E <sub>AS</sub>  | Single Pulse Avalanche Energy ②                     | 303           | mJ    |
| I <sub>AR</sub>  | Avalanche Current ①                                 | -33.5         | A     |
| E <sub>AR</sub>  | Repetitive Avalanche Energy ①                       | 25            | mJ    |
| dv/dt  | Peak Diode Recovery dv/dt ③                         | -10           | V/ns  |
| T <sub>J</sub><br>T <sub>STG</sub>                               | Operating Junction and<br>Storage Temperature Range | -55 to + 150  | °C    |
|  | Lead Temperature                                    | 300 (for 5s)  |       |
|  | Weight  | 3.3 (Typical) |       |

For Footnotes, refer to the page 2.

### Electrical Characteristics @ T<sub>J</sub> = 25°C (Unless Otherwise Specified)

| Symbol                              | Parameter                            | Min. | Typ.  | Max.  | Units | Test Conditions   |
|-------------------------------------|--------------------------------------|------|-------|-------|-------|---|
| BV <sub>DSS</sub>                   | Drain-to-Source Breakdown Voltage    | -200 | —     | —     | V     | V <sub>GS</sub> = 0V, I <sub>D</sub> = -1.0mA                         |
| ΔBV <sub>DSS</sub> /ΔT <sub>J</sub> | Breakdown Voltage Temp. Coefficient  | —    | -0.25 | —     | V/°C  | Reference to 25°C, I <sub>D</sub> = -1.0mA                            |
| R <sub>DS(on)</sub>                 | Static Drain-to-Source On-Resistance | —    | —     | 0.102 | Ω     | V <sub>GS</sub> = -12V, I <sub>D2</sub> = -21A ④                      |
| V <sub>GS(th)</sub>                 | Gate Threshold Voltage               | -2.0 | —     | -4.0  | V     | V <sub>DS</sub> = V <sub>GS</sub> , I <sub>D</sub> = -1.0mA           |
| G <sub>fs</sub>                     | Forward Transconductance             | 23   | —     | —     | S     | V <sub>DS</sub> = -15V, I <sub>D2</sub> = -21A ④                      |
| I <sub>DSS</sub>                    | Zero Gate Voltage Drain Current      | —    | —     | -10   | μA    | V <sub>DS</sub> = -160V, V <sub>GS</sub> = 0V                         |
|                                     |                                      | —    | —     | -25   |       | V <sub>DS</sub> = -160V, V <sub>GS</sub> = 0V, T <sub>J</sub> = 125°C |
| I <sub>GSS</sub>                    | Gate-to-Source Leakage Forward       | —    | —     | -100  | nA    | V <sub>GS</sub> = -20V  |
|                                     | Gate-to-Source Leakage Reverse       | —    | —     | 100   |       | V <sub>GS</sub> = 20V   |
| Q <sub>G</sub>                      | Total Gate Charge                    | —    | —     | 180   | nC    | I <sub>D1</sub> = -33.5A  |
| Q <sub>GS</sub>                     | Gate-to-Source Charge                | —    | —     | 75    |       | V <sub>DS</sub> = -100V   |
| Q <sub>GD</sub>                     | Gate-to-Drain ('Miller') Charge      | —    | —     | 50    |       | V <sub>GS</sub> = -12V  |
| t <sub>d(on)</sub>                  | Turn-On Delay Time                   | —    | —     | 35    | ns    | V <sub>DD</sub> = -100V   |
| t <sub>r</sub>                      | Rise Time                            | —    | —     | 100   |       | I <sub>D1</sub> = -33.5A  |
| t <sub>d(off)</sub>                 | Turn-Off Delay Time                  | —    | —     | 100   |       | R <sub>G</sub> = 2.35Ω  |
| t <sub>f</sub>                      | Fall Time                            | —    | —     | 120   |       | V <sub>GS</sub> = -12V  |
| L <sub>S</sub> + L <sub>D</sub>     | Total Inductance                     | —    | 4.0   | —     | nH    | Measured from center of Drain pad to center of Source pad             |
| C <sub>iss</sub>                    | Input Capacitance                    | —    | 7170  | —     | pF    | V <sub>GS</sub> = 0V  |
| C <sub>oss</sub>                    | Output Capacitance                   | —    | 920   | —     |       | V <sub>DS</sub> = -25V  |
| C <sub>rss</sub>                    | Reverse Transfer Capacitance         | —    | 86    | —     |       | f = 1.0MHz  |

### Source-Drain Diode Ratings and Characteristics

| Symbol          | Parameter                              | Min.  | Typ. | Max.  | Units | Test Conditions  |
|-----------------|--|---|------|-------|-------|--|
| I <sub>S</sub>  | Continuous Source Current (Body Diode) | —   | —    | -33.5 | A     |  |
| I <sub>SM</sub> | Pulsed Source Current (Body Diode) ①   | —   | —    | -134  |       |  |
| V <sub>SD</sub> | Diode Forward Voltage                  | —   | —    | -5.0  | V     | T <sub>J</sub> = 25°C, I <sub>S</sub> = -33.5A, V <sub>GS</sub> = 0V ② |
| t <sub>rr</sub> | Reverse Recovery Time                  | —   | —    | 450   | ns    | T <sub>J</sub> = 25°C, I <sub>F</sub> = -33.5A, V <sub>DD</sub> ≤ -50V |
| Q <sub>rr</sub> | Reverse Recovery Charge                | —   | —    | 5.5   | μC    | di/dt = -100A/μs ④   |
| t <sub>on</sub> | Forward Turn-On Time                   | Intrinsic turn-on time is negligible (turn-on is dominated by L <sub>S</sub> + L <sub>D</sub> ) |      |       |       |  |

### Thermal Resistance

| Symbol              | Parameter  | Min. | Typ. | Max. | Units |
|---------------------|--|------|------|------|-------|
| R <sub>θJC</sub>    | Junction-to-Case   | —    | —    | 0.5  | °C/W  |
| R <sub>θJ-PCB</sub> | Junction-to-PC Board (Soldered to 2" sq copper clad board) | —    | 1.6  | —    |       |

### Footnotes:

- ① Repetitive Rating; Pulse width limited by maximum junction temperature.
- ② V<sub>DD</sub> = -50V, starting T<sub>J</sub> = 25°C, L = 0.54mH, Peak I<sub>L</sub> = -33.5A, V<sub>GS</sub> = -12V
- ③ I<sub>SD</sub> ≤ -33.5A, di/dt ≤ -450A/μs, V<sub>DD</sub> ≤ -200V, T<sub>J</sub> ≤ 150°C
- ④ Pulse width ≤ 300 μs; Duty Cycle ≤ 2%
- ⑤ Total Dose Irradiation with V<sub>GS</sub> Bias. -12 volt V<sub>GS</sub> applied and V<sub>DS</sub> = 0 during irradiation per MIL-STD-750, Method 1019, condition A.
- ⑥ Total Dose Irradiation with V<sub>DS</sub> Bias. -160 volt V<sub>DS</sub> applied and V<sub>GS</sub> = 0 during irradiation per MIL-STD-750, Method 1019, condition A.

## Radiation Characteristics

IR HiRel radiation hardened MOSFETs are tested to verify their radiation hardness capability. The hardness assurance program at IR HiRel is comprised of two radiation environments. Every manufacturing lot is tested for total ionizing dose (per notes 5 and 6) using the TO-3 package. Both pre- and post-irradiation performance are tested and specified using the same drive circuitry and test conditions in order to provide a direct comparison.

**Table1. Electrical Characteristics @ Tj = 25°C, Post Total Dose Irradiation ⑤⑥**

| Symbol              | Parameter  | 100 kRads (Si) <sup>1</sup> |       | 300 kRads (Si) <sup>2</sup> |       | Units | Test Conditions   |
|---------------------|--|-----------------------------|-------|-----------------------------|-------|-------|---|
|                     |  | Min.                        | Max.  | Min.                        | Max.  |       |   |
| BV <sub>DSS</sub>   | Drain-to-Source Breakdown Voltage                      | -200                        | —     | -200                        | —     | V     | V <sub>GS</sub> = 0V, I <sub>D</sub> = -1.0mA               |
| V <sub>GS(th)</sub> | Gate Threshold Voltage                                 | -2.0                        | -4.0  | -2.0                        | -5.0  | V     | V <sub>DS</sub> = V <sub>GS</sub> , I <sub>D</sub> = -1.0mA |
| I <sub>GSS</sub>    | Gate-to-Source Leakage Forward                         | —                           | -100  | —                           | -100  | nA    | V <sub>GS</sub> = -20V                                      |
| I <sub>GSS</sub>    | Gate-to-Source Leakage Reverse                         | —                           | 100   | —                           | 100   | nA    | V <sub>GS</sub> = 20V                                       |
| I <sub>DSS</sub>    | Zero Gate Voltage Drain Current                        | —                           | -10   | —                           | -10   | μA    | V <sub>DS</sub> = -160V, V <sub>GS</sub> = 0V               |
| R <sub>DS(on)</sub> | Static Drain-to-Source ④<br>On-State Resistance (TO-3) | —                           | 0.103 | —                           | 0.103 | Ω     | V <sub>GS</sub> = -12V, I <sub>D2</sub> = -21A              |
| V <sub>SD</sub>     | Diode Forward Voltage ④                                | —                           | -5.0  | —                           | -5.0  | V     | V <sub>GS</sub> = 0V, I <sub>S</sub> = -33.5A               |

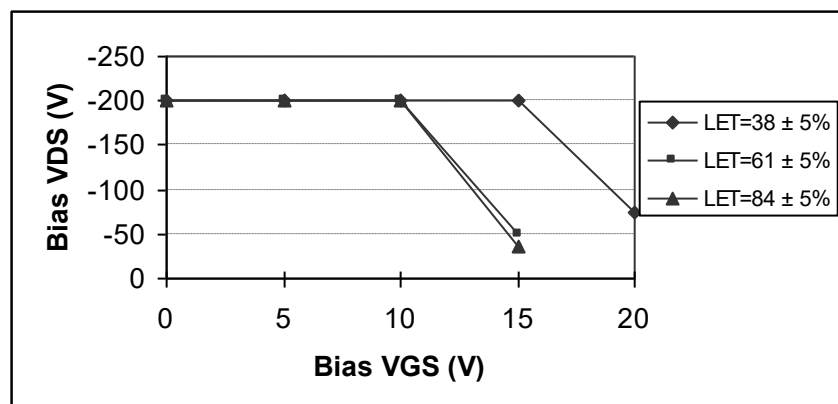
1. Part numbers IRHNS597260 (JANSR2N7549U2A)

2. Part numbers IRHNS593260 (JANSF2N7549U2A)

IR HiRel radiation hardened MOSFETs have been characterized in heavy ion environment for Single Event Effects (SEE). Single Event Effects characterization is illustrated in Fig. a and Table 2.

**Table 2. Typical Single Event Effect Safe Operating Area**

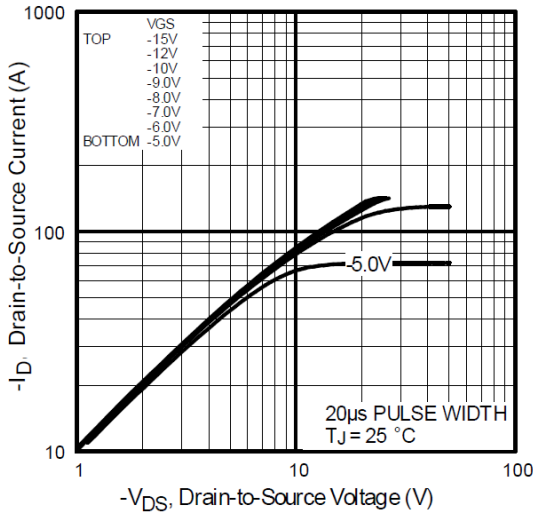
| LET<br>(MeV/(mg/cm <sup>2</sup> )) | Energy<br>(MeV) | Range<br>(μm) | VDS (V)    |           |            |            |            |
|------------------------------------|-----------------|---------------|------------|-----------|------------|------------|------------|
|                                    |                 |               | @ VGS = 0V | @ VGS =5V | @ VGS =10V | @ VGS =15V | @ VGS =20V |
| 38 ± 5%                            | 270 ± 7.5%      | 35 ± 7.5%     | -200       | -200      | -200       | -200       | -75        |
| 61 ± 5%                            | 330 ± 7.5%      | 31 ± 7.5%     | -200       | -200      | -200       | -50        | —          |
| 84 ± 5%                            | 350 ± 7.5%      | 28 ± 7.5%     | -200       | -200      | -200       | -35        | —          |



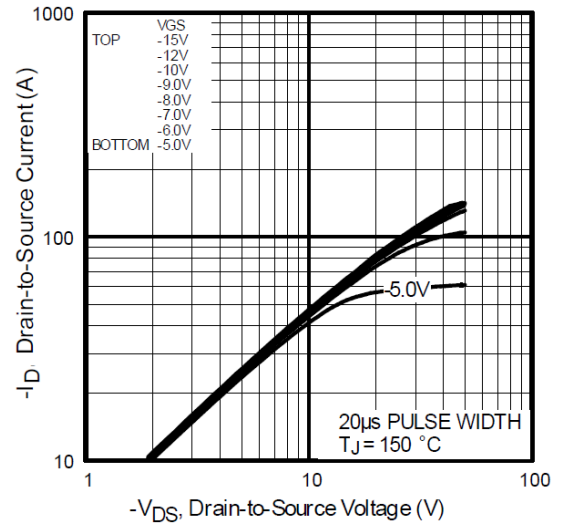
**Fig a.** Typical Single Event Effect, Safe Operating Area

For Footnotes, refer to the page 2.

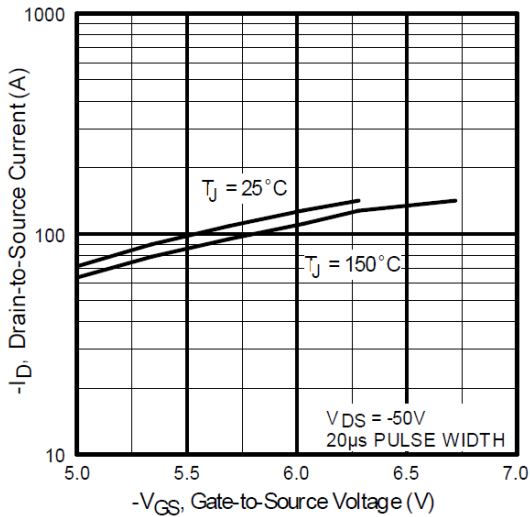
**Pre-Irradiation**



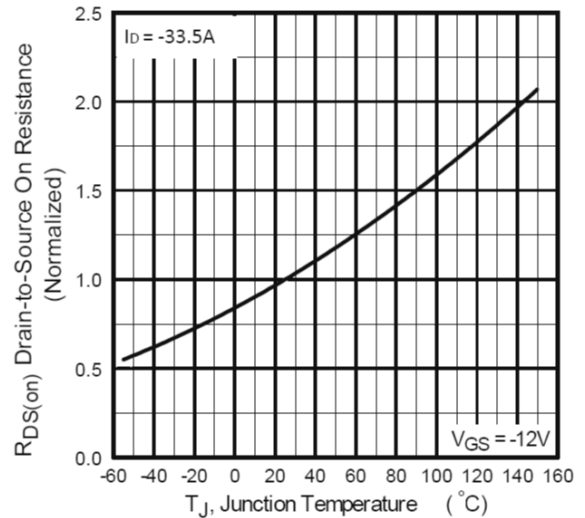
**Fig 1. Typical Output Characteristics**



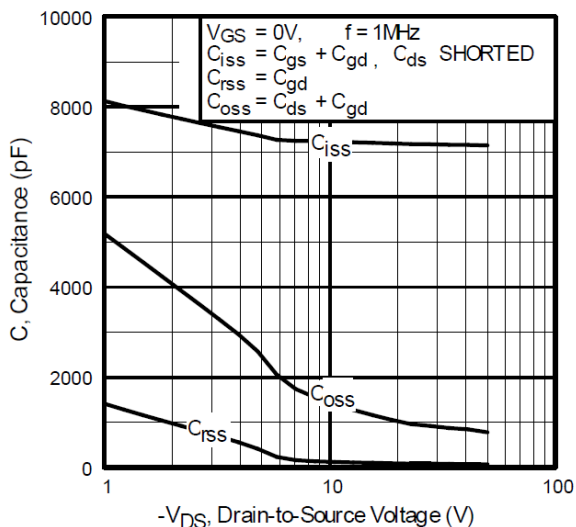
**Fig 2. Typical Output Characteristics**



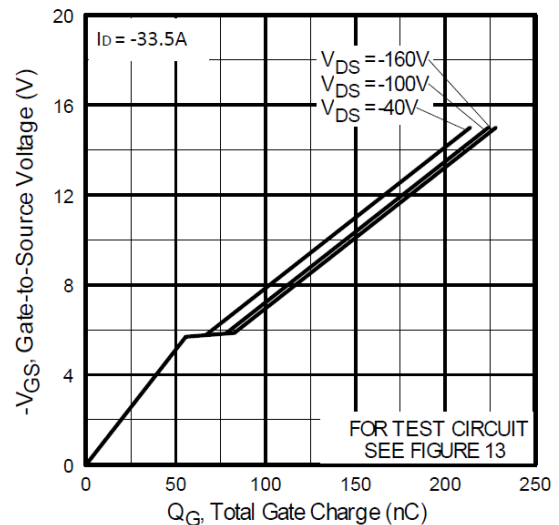
**Fig 3. Typical Transfer Characteristics**



**Fig 4. Normalized On-Resistance Vs. Temperature**

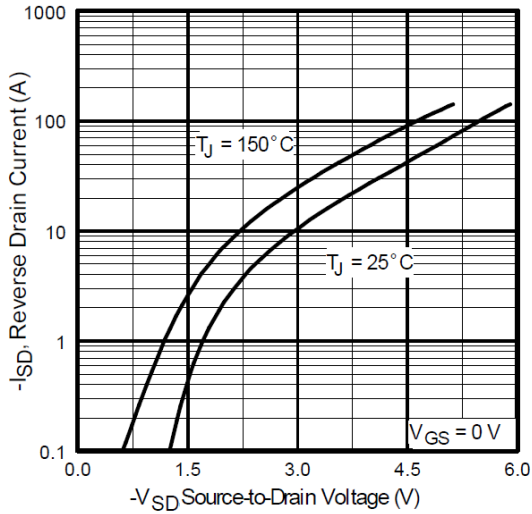


**Fig 5. Typical Capacitance Vs. Drain-to-Source Voltage**

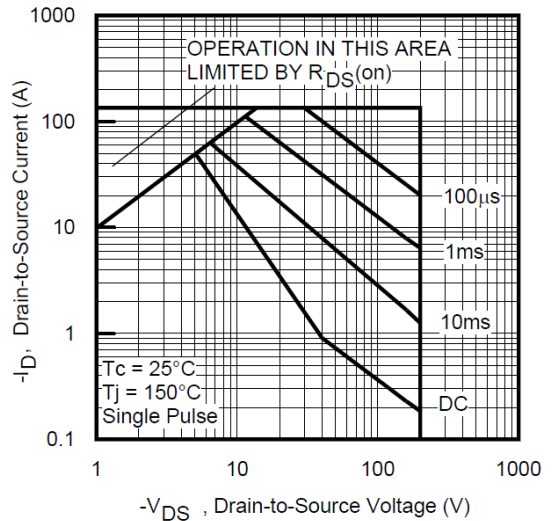


**Fig 6. Typical Gate Charge Vs. Gate-to-Source Voltage**

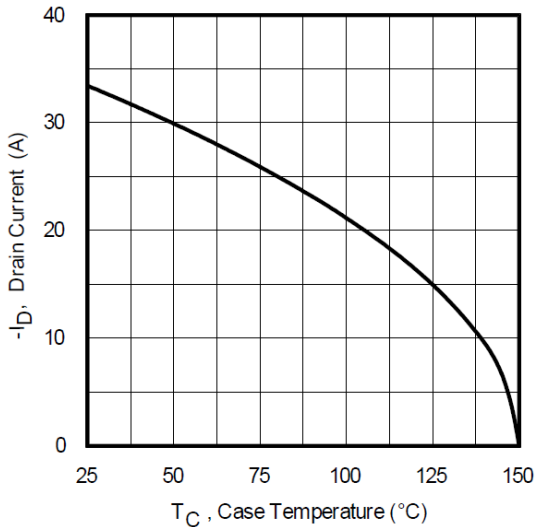
**Pre-Irradiation**



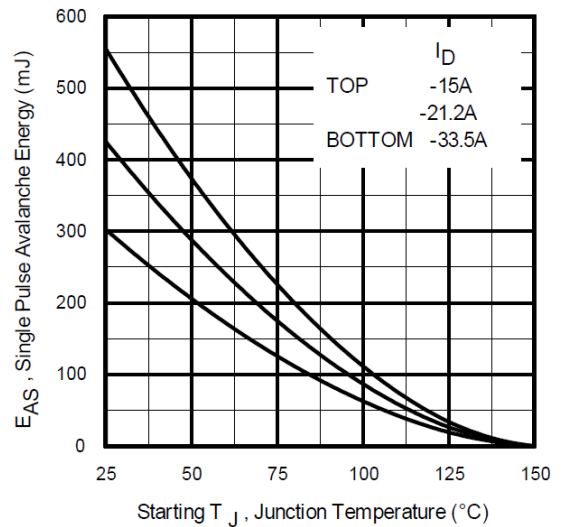
**Fig 7.** Typical Source-Drain Diode Forward Voltage



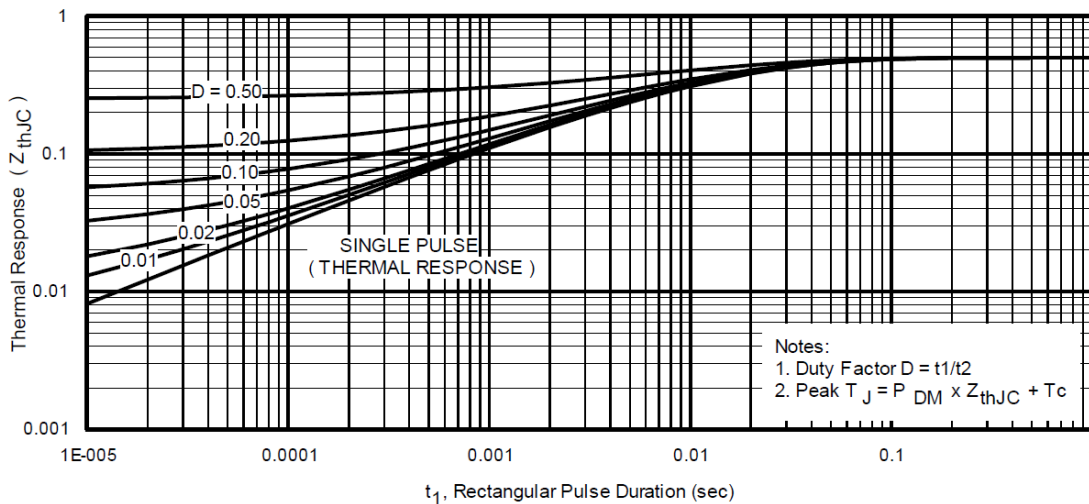
**Fig 8.** Maximum Safe Operating Area



**Fig 9.** Maximum Drain Current Vs. Case Temperature

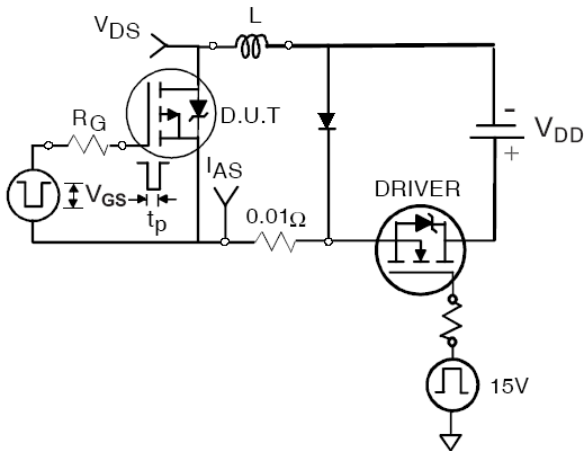


**Fig 10.** Maximum Avalanche Energy Vs. Drain Current

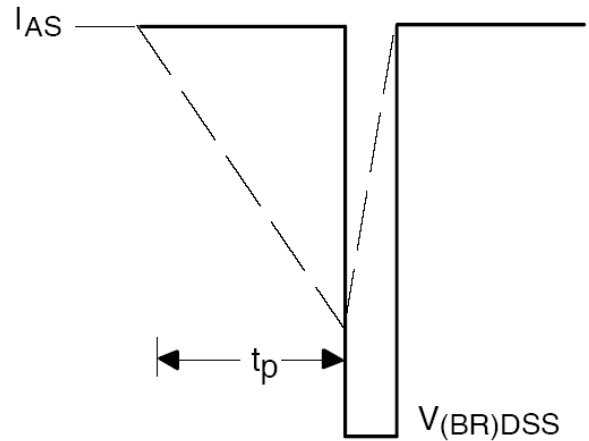


**Fig 11.** Maximum Effective Transient Thermal Impedance, Junction-to-Case

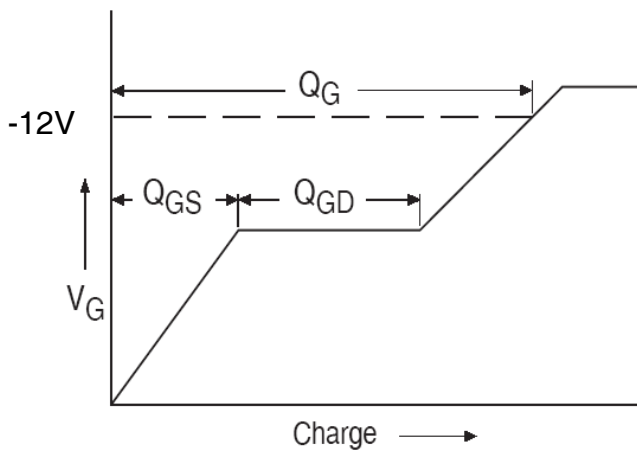
Pre-Irradiation



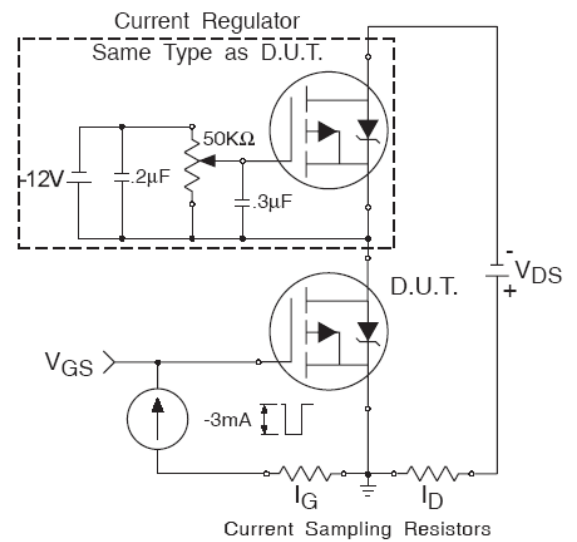
**Fig 12a.** Unclamped Inductive Test Circuit



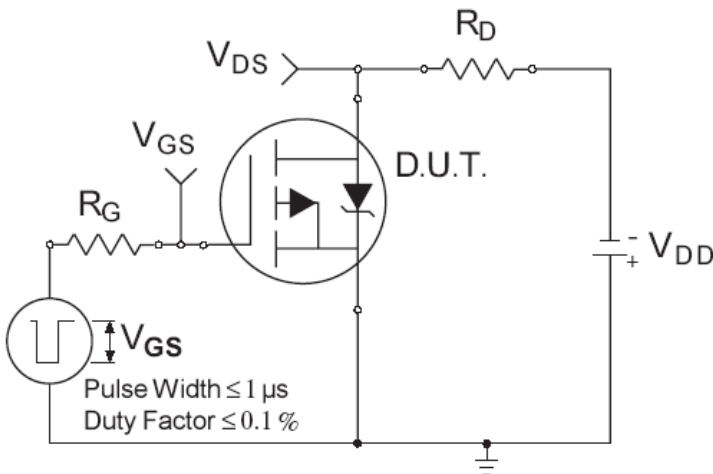
**Fig 12b.** Unclamped Inductive Wave-



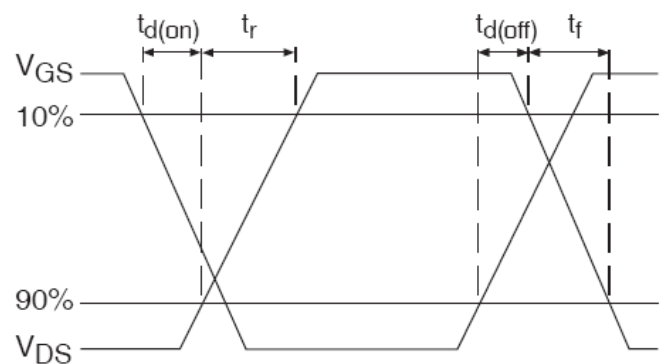
**Fig 13a.** Basic Gate Charge Waveform



**Fig 13b.** Gate Charge Test Circuit



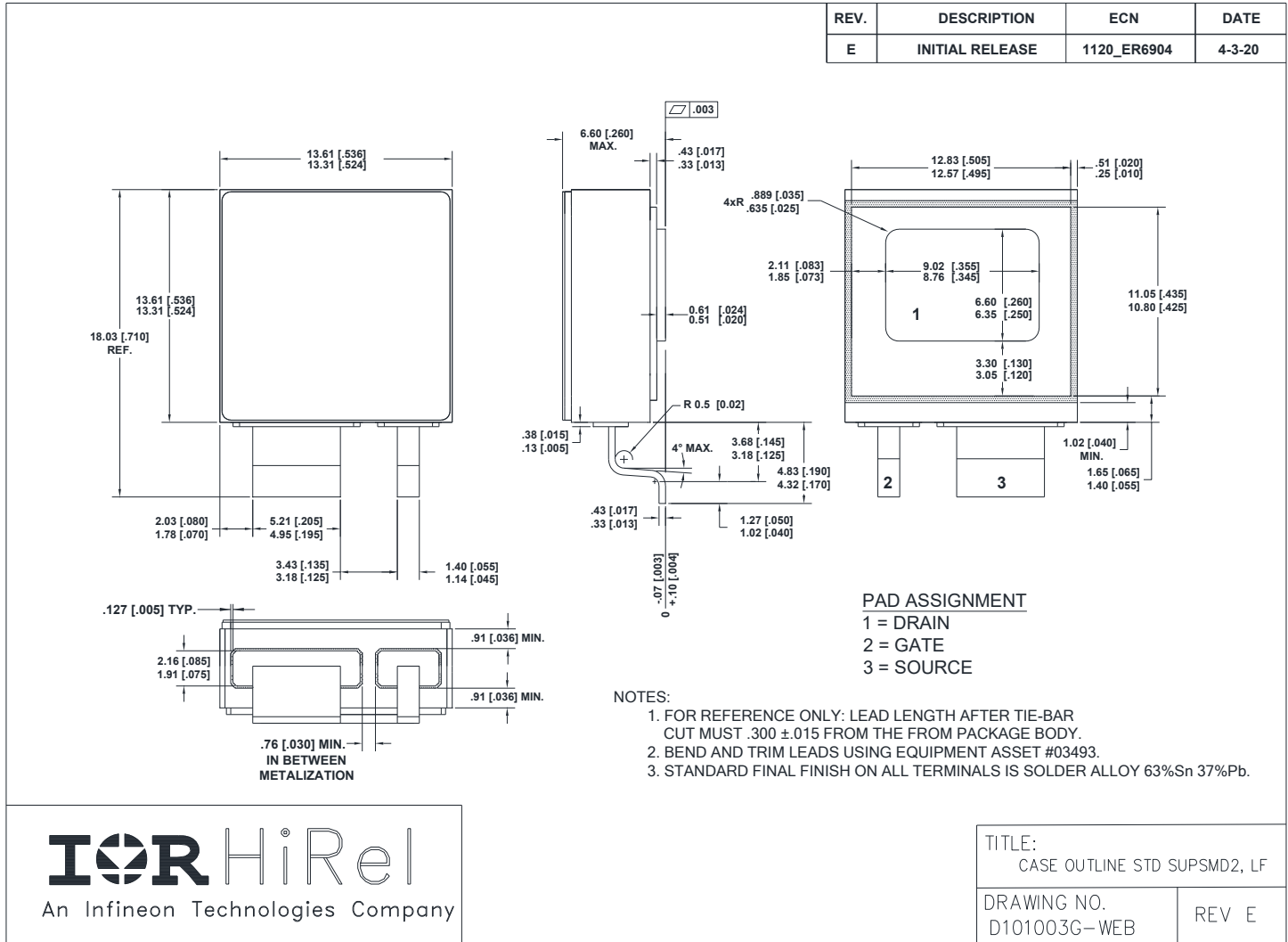
**Fig 14a.** Switching Time Test Circuit



**Fig 14b.** Switching Time Waveforms

Note: For the most updated package outline, please see the website: [SupIR-SMD](http://SupIR-SMD)

**Case Outline and Dimensions - SupIR-SMD**



### **IMPORTANT NOTICE**

The information given in this document shall be in no event regarded as guarantee of conditions or characteristic. The data contained herein is a characterization of the component based on internal standards and is intended to demonstrate and provide guidance for typical part performance. It will require further evaluation, qualification and analysis to determine suitability in the application environment to confirm compliance to your system requirements.

With respect to any example hints or any typical values stated herein and/or any information regarding the application of the product, Infineon Technologies hereby disclaims any and all warranties and liabilities of any kind including without limitation warranties on non- infringement of intellectual property rights and any third party.

In addition, any information given in this document is subject to customer's compliance with its obligations stated in this document and any applicable legal requirements, norms and standards concerning customer's product and any use of the product of Infineon Technologies in customer's applications.

The data contained in this document is exclusively intended for technically trained staff. It is the responsibility of any customer's technical departments to evaluate the suitability of the product for the intended applications and the completeness of the product information given in this document with respect to applications.

For further information on the product, technology, delivery terms and conditions and prices, please contact your local sales representative or go to [www.infineon.com/irhirel](http://www.infineon.com/irhirel)

### **WARNING**

Due to technical requirements products may contain dangerous substances. For information on the types in question, please contact your nearest Infineon Technologies office.