

**RADIATION HARDENED
POWER MOSFET
THRU-HOLE TO-205AF (TO-39)**

**100V, P-CHANNEL
R5 TECHNOLOGY**

Product Summary

Part Number	Radiation Level	RDS(on)	I _D
IRHF597130	100 kRads(Si)	0.24Ω	-6.7A
IRHF593130	300 kRads(Si)	0.24Ω	-6.7A

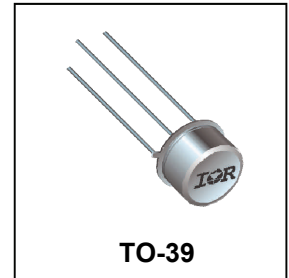

Description

IR HiRel R5 technology provides high performance power MOSFETs for space applications. These devices have been characterized for both Total Dose and Single Event Effect (SEE) with useful performance up to LET of 80 (MeV/(mg/cm²)). The combination of low RDS(on) and low gate charge reduces the power losses in switching applications such as DC-DC converters and motor controllers. These devices retain all of the well established advantages of MOSFETs such as voltage control, fast switching and temperature stability of electrical parameters.

Features

- Single Event Effect (SEE) Hardened
- Low RDS(on)
- Low Total Gate Charge
- Simple Drive Requirements
- Hermetically Sealed
- Electrically Isolated
- Ceramic Package
- Light Weight
- Surface Mount
- ESD Rating: Class 1B per MIL-STD-750, Method 1020

Absolute Maximum Ratings

Pre-Irradiation

Symbol	Parameter	Value	Units
I _{D1} @ V _{GS} = -12V, T _C = 25°C	Continuous Drain Current	-6.7	A
I _{D2} @ V _{GS} = -12V, T _C = 100°C	Continuous Drain Current	-4.3	
I _{DM} @ T _C = 25°C	Pulsed Drain Current ①	-26.8	
P _D @ T _C = 25°C	Maximum Power Dissipation	25	W
	Linear Derating Factor	0.2	W/°C
V _{GS}	Gate-to-Source Voltage	± 20	V
E _{AS}	Single Pulse Avalanche Energy ②	240	mJ
I _{AR}	Avalanche Current ①	-6.7	A
E _{AR}	Repetitive Avalanche Energy ①	2.5	mJ
dv/dt	Peak Diode Recovery dv/dt ③	-17	V/ns
T _J T _{STG}	Operating Junction and Storage Temperature Range	-55 to + 150	°C
	Lead Temperature	300 (0.063 in. /1.6 mm from case for 10s)	
	Weight	0.98 (Typical)	

For Footnotes, refer to the page 2.

Electrical Characteristics @ T_J = 25°C (Unless Otherwise Specified)

Symbol	Parameter	Min.	Typ.	Max.	Units	Test Conditions
BV _{DSS}	Drain-to-Source Breakdown Voltage	-100	—	—	V	V _{GS} = 0V, I _D = -1.0mA
ΔBV _{DSS} /ΔT _J	Breakdown Voltage Temp. Coefficient	—	-0.13	—	V/°C	Reference to 25°C, I _D = -1.0mA
R _{DS(on)}	Static Drain-to-Source On-Resistance	—	—	0.24	Ω	V _{GS} = -12V, I _{D2} = -4.3A ④
V _{GS(th)}	Gate Threshold Voltage	-2.0	—	-4.0	V	V _{DS} = V _{GS} , I _D = -1.0mA
G _{fs}	Forward Transconductance	4.3	—	—	S	V _{DS} = -15V, I _{D2} = -4.3A ④
I _{DSS}	Zero Gate Voltage Drain Current	—	—	-10	μA	V _{DS} = -80V, V _{GS} = 0V
		—	—	-25		V _{DS} = -80V, V _{GS} = 0V, T _J = 125°C
I _{GSS}	Gate-to-Source Leakage Forward	—	—	-100	nA	V _{GS} = -20V
	Gate-to-Source Leakage Reverse	—	—	100		V _{GS} = 20V
Q _G	Total Gate Charge	—	—	40	nC	I _{D1} = -6.7A
Q _{GS}	Gate-to-Source Charge	—	—	16		V _{DS} = -50V
Q _{GD}	Gate-to-Drain ('Miller') Charge	—	—	11		V _{GS} = -12V
t _{d(on)}	Turn-On Delay Time	—	—	25	ns	V _{DD} = -50V
t _r	Rise Time	—	—	50		I _{D1} = -6.7A
t _{d(off)}	Turn-Off Delay Time	—	—	45		R _G = 7.5Ω
t _f	Fall Time	—	—	125		V _{GS} = -12V
L _S + L _D	Total Inductance	—	7.0	—	nH	Measured from Drain lead (6mm / 0.25in from package) to Source lead (6mm / 0.25in from package) with Source wire internally bonded from Source pin to Drain pin
C _{iss}	Input Capacitance	—	1250	—	pF	V _{GS} = 0V
C _{oss}	Output Capacitance	—	318	—		V _{DS} = -25V
C _{rss}	Reverse Transfer Capacitance	—	28	—		f = 1.0MHz
R _G	Internal Gate Resistance	—	8.0	—	Ω	f = 1.0MHz, open drain

Source-Drain Diode Ratings and Characteristics

Symbol	Parameter	Min.	Typ.	Max.	Units	Test Conditions
I _S	Continuous Source Current (Body Diode)	—	—	-6.7	A	
I _{SM}	Pulsed Source Current (Body Diode) ①	—	—	-26.8		
V _{SD}	Diode Forward Voltage	—	—	-5.0	V	T _J = 25°C, I _S = -6.7A, V _{GS} = 0V ④
t _{rr}	Reverse Recovery Time	—	—	150	ns	T _J = 25°C, I _F = -6.7A, V _{DD} ≤ -50V
Q _{rr}	Reverse Recovery Charge	—	—	408	nC	di/dt = -100A/μs ④
t _{on}	Forward Turn-On Time	Intrinsic turn-on time is negligible (turn-on is dominated by L _S +L _D)				

Thermal Resistance

Symbol	Parameter	Min.	Typ.	Max.	Units
R _{θJC}	Junction-to-Case	—	—	5.0	°C/W
R _{θJA}	Junction-to-Ambient (Typical Socket Mount)	—	—	175	°C/W

Footnotes:

- ① Repetitive Rating; Pulse width limited by maximum junction temperature.
- ② V_{DD} = -25V, starting T_J = 25°C, L = 10.6mH, Peak I_L = -6.7A, V_{GS} = -12V
- ③ I_{SD} ≤ -6.7A, di/dt ≤ -530A/μs, V_{DD} ≤ -100V, T_J ≤ 150°C
- ④ Pulse width ≤ 300 μs; Duty Cycle ≤ 2%
- ⑤ Total Dose Irradiation with V_{GS} Bias. -12 volt V_{GS} applied and V_{DS} = 0 during irradiation per MIL-STD-750, Method 1019, condition A.
- ⑥ Total Dose Irradiation with V_{DS} Bias. -80 volt V_{DS} applied and V_{GS} = 0 during irradiation per MIL-STD-750, Method 1019, condition A.

Radiation Characteristics

IR HiRel Radiation Hardened MOSFETs are tested to verify their radiation hardness capability. The hardness assurance program at IR HiRel is comprised of two radiation environments. Every manufacturing lot is tested for total ionizing dose (per notes 5 and 6) using the TO-3 package. Both pre- and post-irradiation performance are tested and specified using the same drive circuitry and test conditions in order to provide a direct comparison.

Table1. Electrical Characteristics @ Tj = 25°C, Post Total Dose Irradiation ⑤⑥

Symbol	Parameter	100 kRads (Si) ¹		300 kRads (Si) ²		Units	Test Conditions
		Min.	Max.	Min.	Max.		
BV _{DSS}	Drain-to-Source Breakdown Voltage	-100	—	-100	—	V	V _{GS} = 0V, I _D = -1.0mA
V _{GS(th)}	Gate Threshold Voltage	-2.0	-4.0	-2.0	-5.0	V	V _{DS} = V _{GS} , I _D = -1.0mA
I _{GSS}	Gate-to-Source Leakage Forward	—	-100	—	-100	nA	V _{GS} = -20V
I _{GSS}	Gate-to-Source Leakage Reverse	—	100	—	100	nA	V _{GS} = 20V
I _{DSS}	Zero Gate Voltage Drain Current	—	-10	—	-10	μA	V _{DS} = -80V, V _{GS} = 0V
R _{DS(on)}	Static Drain-to-Source ④ On-State Resistance (TO-3)	—	0.205	—	0.205	Ω	V _{GS} = -12V, I _{D2} = -4.3A
R _{DS(on)}	Static Drain-to-Source ④ On-State Resistance (TO-39)	—	0.24	—	0.24	Ω	V _{GS} = -12V, I _{D2} = -4.3A
V _{SD}	Diode Forward Voltage ④	—	-5.0	—	-5.0	V	V _{GS} = 0V, I _S = -6.7A

1. Part number IRHF597130
2. Part number IRHF593130

IR HiRel radiation hardened MOSFETs have been characterized in heavy ion environment for Single Event Effects (SEE). Single Event Effects characterization is illustrated in Fig. a and Table 2.

Table 2. Typical Single Event Effect Safe Operating Area

LET (MeV/(mg/cm ²))	Energy (MeV)	Range (μm)	VDS (V)				
			@ VGS = 0V	@ VGS =5V	@ VGS =10V	@ VGS =15V	@ VGS =20V
38 ± 5%	270 ± 7.5%	35 ± 7.5%	-100	-100	-100	-100	-100
61 ± 5%	330 ± 7.5%	30 ± 7.5%	-100	-100	-100	-100	-25
84 ± 5%	350 ± 7.5%	28 ± 7.5%	-100	-100	-100	-30	—

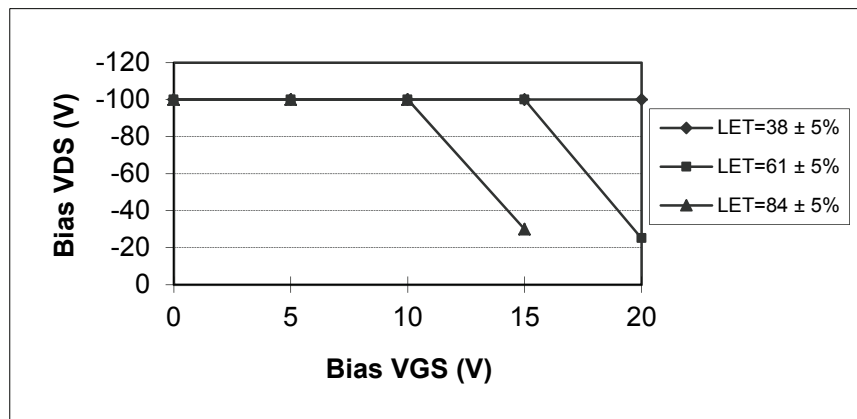

Fig a. Typical Single Event Effect, Safe Operating Area

For Footnotes, refer to the page 2.

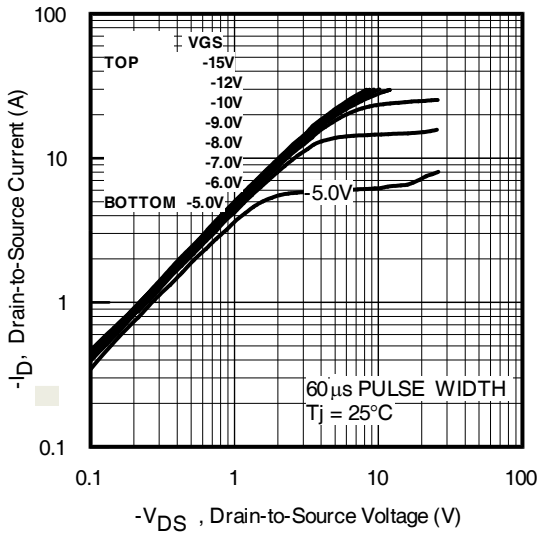

Fig 1. Typical Output Characteristics

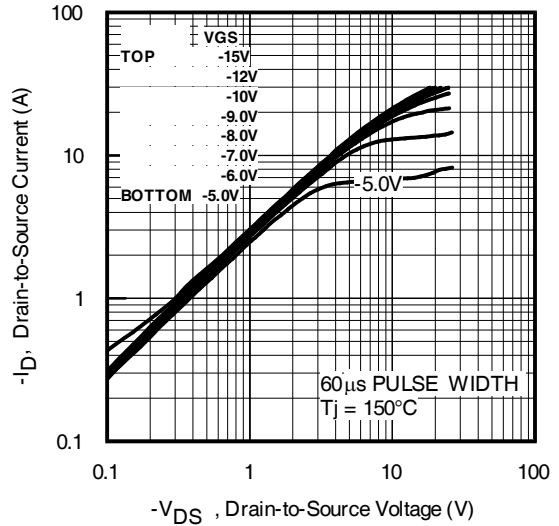

Fig 2. Typical Output Characteristics

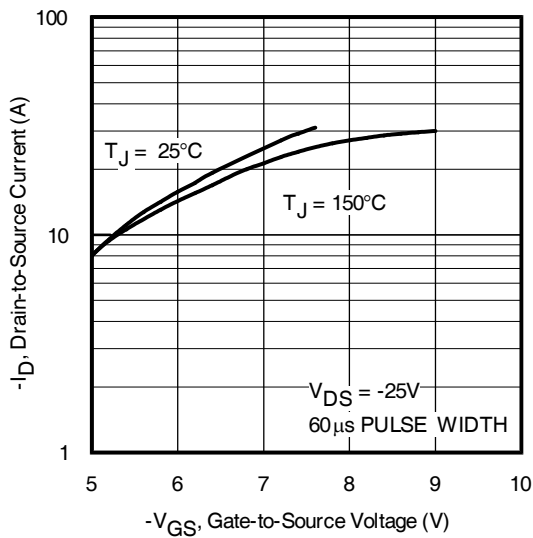

Fig 3. Typical Transfer Characteristics

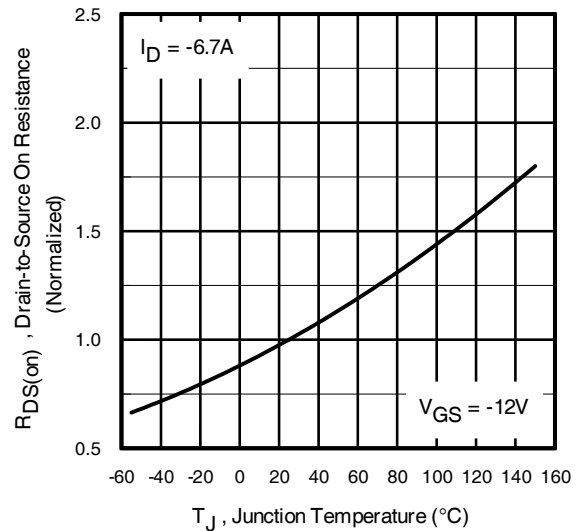

Fig 4. Normalized On-Resistance Vs. Temperature

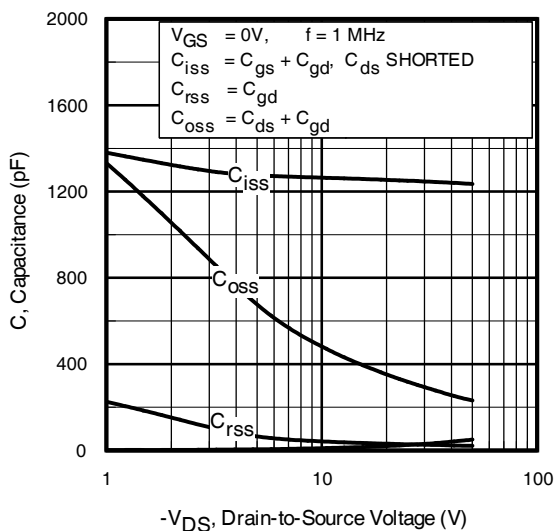

Fig 5. Typical Capacitance Vs. Drain-to-Source Voltage

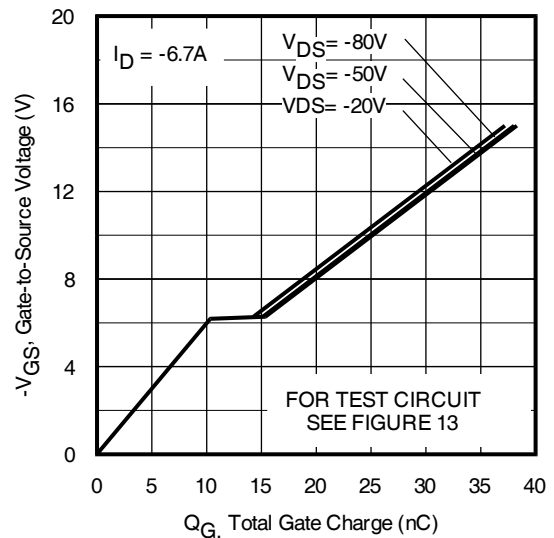

Fig 6. Typical Gate Charge Vs. Gate-to-Source Voltage

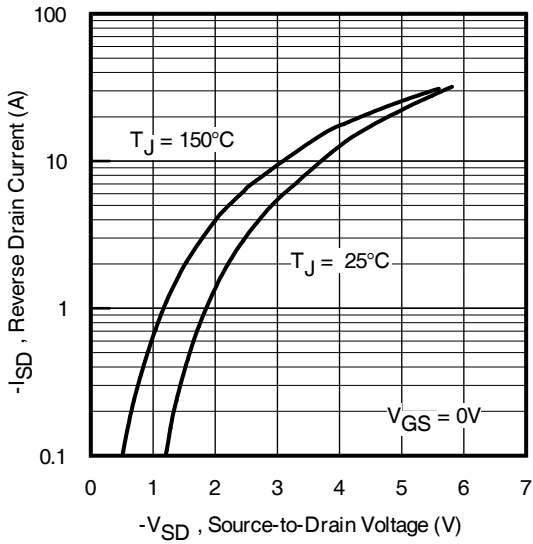

Fig 7. Typical Source-Drain Diode Forward Voltage

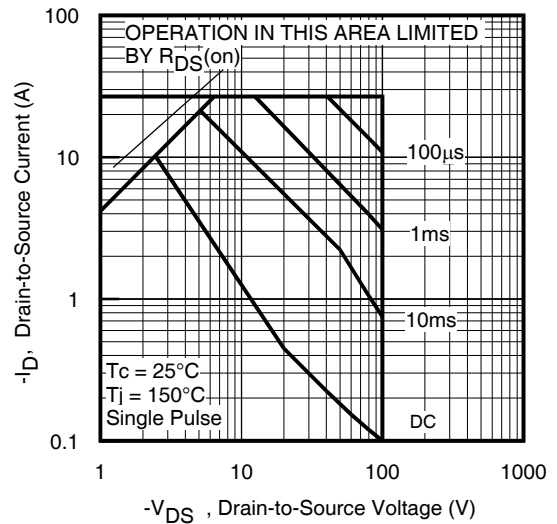

Fig 8. Maximum Safe Operating Area

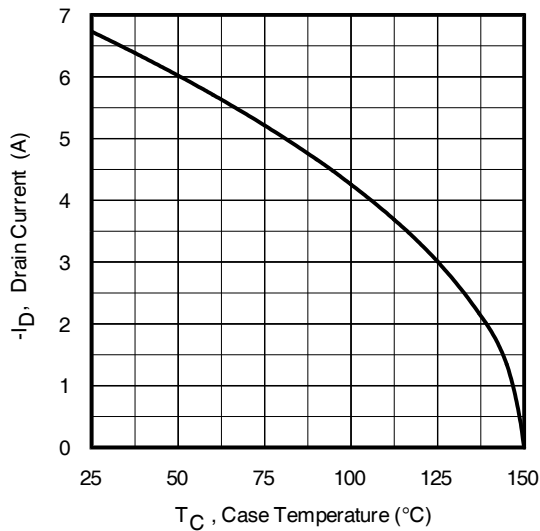

Fig 9. Maximum Drain Current Vs. Case Temperature

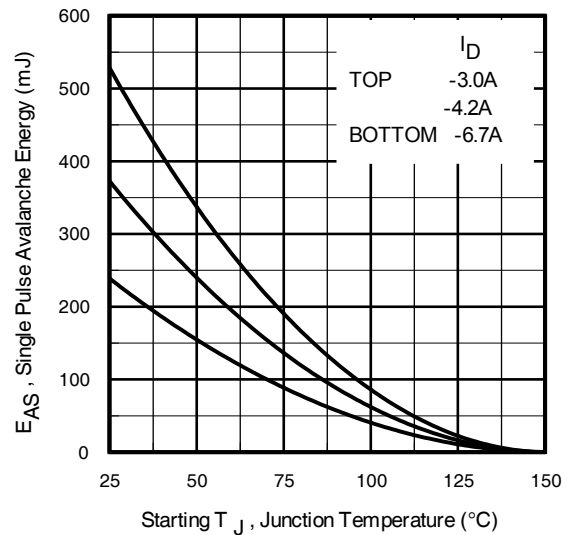

Fig 10. Maximum Avalanche Energy Vs. Drain Current

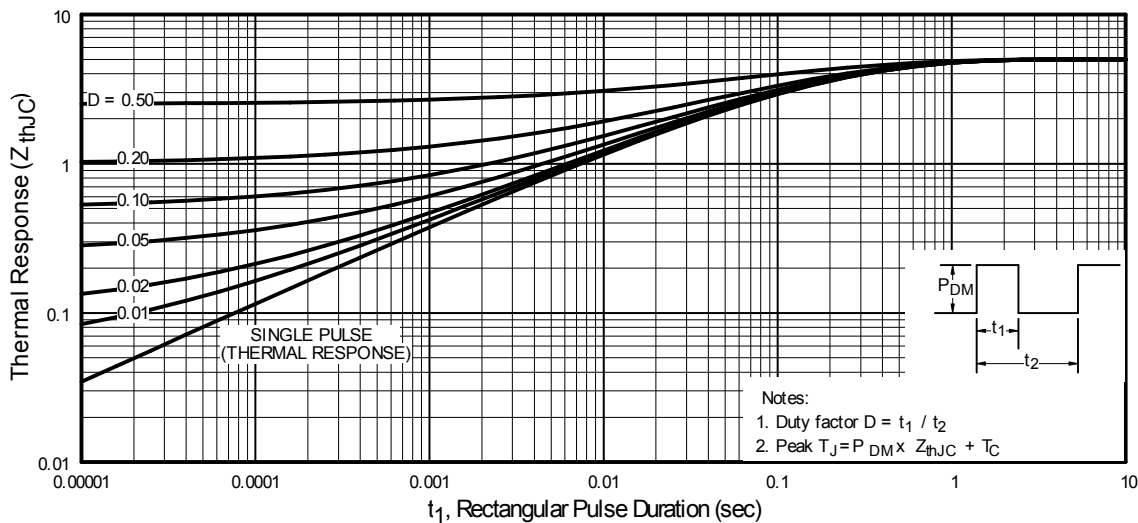

Fig 11. Maximum Effective Transient Thermal Impedance, Junction-to-Case

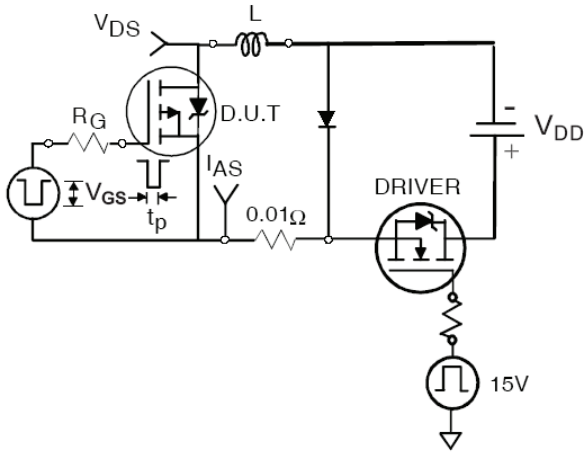

Fig 12a. Unclamped Inductive Test Circuit

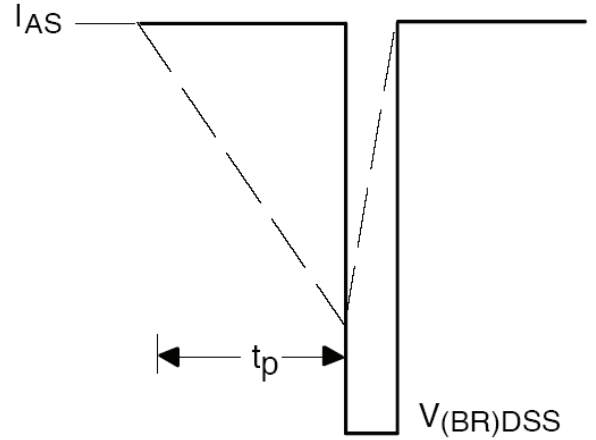

Fig 12b. Unclamped Inductive Waveforms

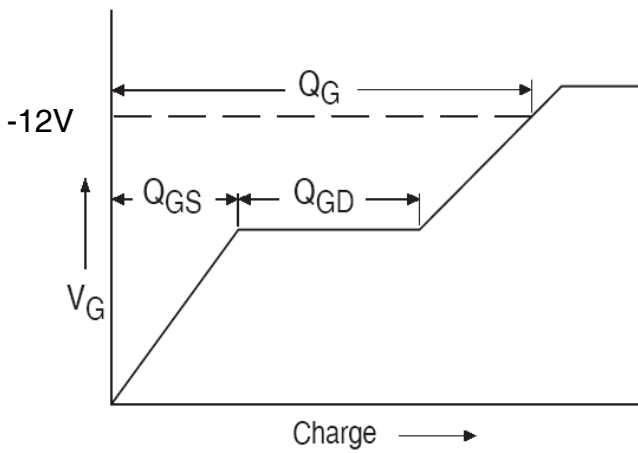

Fig 13a. Basic Gate Charge Waveform

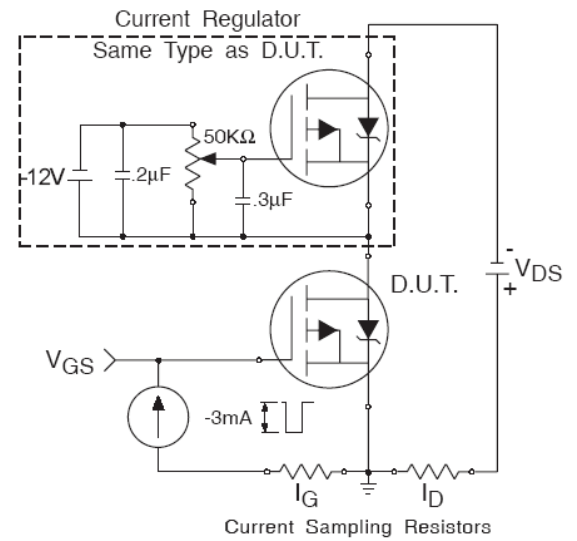

Fig 13b. Gate Charge Test Circuit

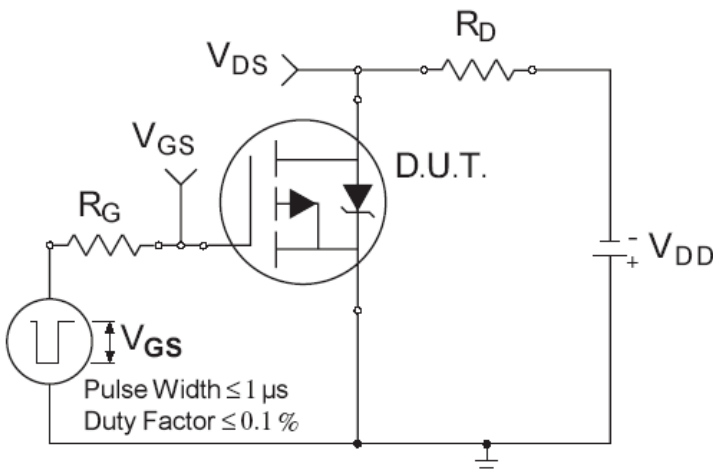

Fig 14a. Switching Time Test Circuit

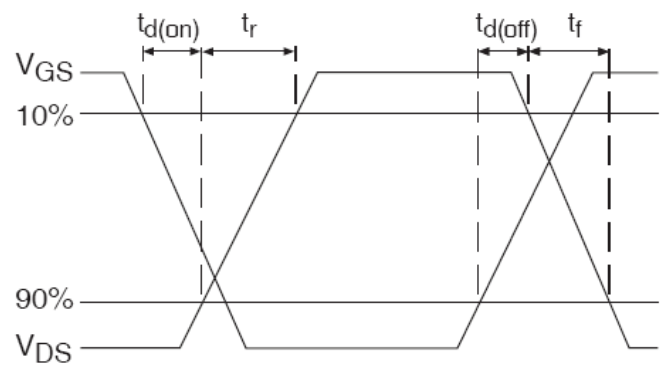
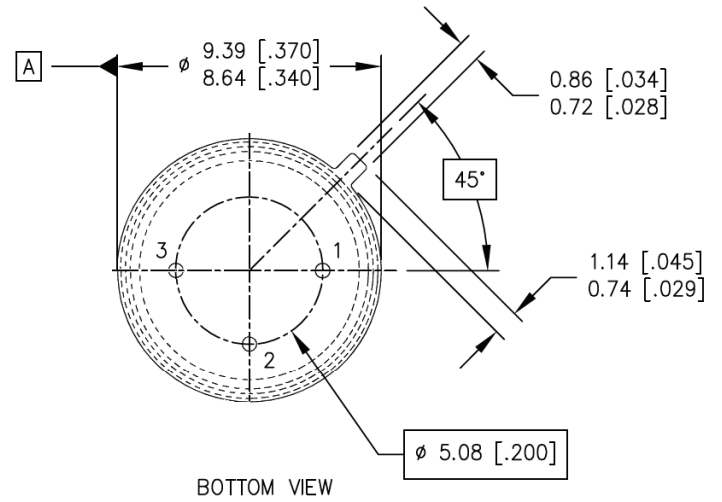
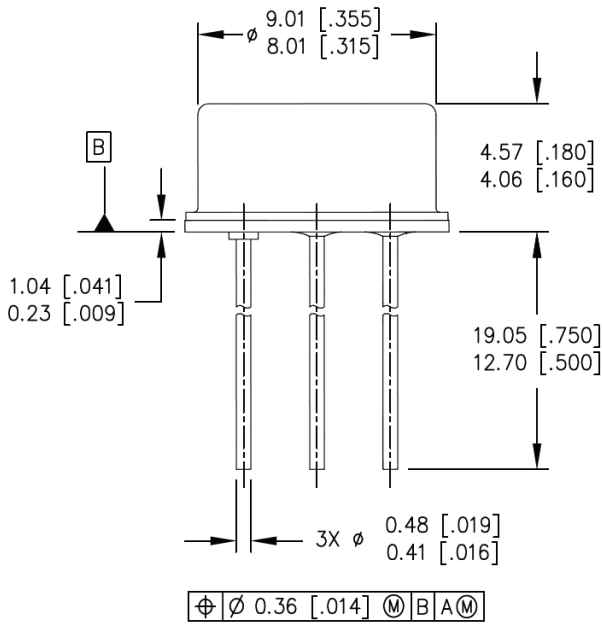

Fig 14b. Switching Time Waveforms

Case Outline and Dimensions - TO-205AF (TO-39)



LEGEND
 1- SOURCE
 2- GATE
 3- DRAIN (CONNECTED TO THE CASE)

- NOTES:**
1. DIMENSIONING AND TOLERANCING PER ASME 14.5M-1994.
 2. DIMENSIONS ARE SHOWN IN MILLIMETERS [INCHES].
 3. CONTROLLING DIMENSION: INCH.
 4. CONFORMS TO JEDEC OUTLINE TO-205AF (TO-39).

SIDE VIEW

BOTTOM VIEW

IMPORTANT NOTICE

The information given in this document shall be in no event regarded as guarantee of conditions or characteristic. The data contained herein is a characterization of the component based on internal standards and is intended to demonstrate and provide guidance for typical part performance. It will require further evaluation, qualification and analysis to determine suitability in the application environment to confirm compliance to your system requirements.

With respect to any example hints or any typical values stated herein and/or any information regarding the application of the product, Infineon Technologies hereby disclaims any and all warranties and liabilities of any kind including without limitation warranties on non- infringement of intellectual property rights and any third party.

In addition, any information given in this document is subject to customer's compliance with its obligations stated in this document and any applicable legal requirements, norms and standards concerning customer's product and any use of the product of Infineon Technologies in customer's applications.

The data contained in this document is exclusively intended for technically trained staff. It is the responsibility of any customer's technical departments to evaluate the suitability of the product for the intended applications and the completeness of the product information given in this document with respect to applications.

For further information on the product, technology, delivery terms and conditions and prices, please contact your local sales representative or go to (www.infineon.com/hirel).

WARNING

Due to technical requirements products may contain dangerous substances. For information on the types in question, please contact your nearest Infineon Technologies office.