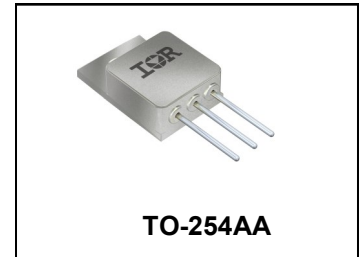

**POWER MOSFET
THRU-HOLE (TO-254AA)**
**60V, N-CHANNEL
HEXFET MOSFET TECHNOLOGY**
Product Summary

Part Number	$R_{DS(on)}$	I_D
IRFM054	0.027 Ω	35A*

Description

HEXFET MOSFET technology is the key to IR HiRel advanced line of power MOSFET transistors. The efficient geometry design achieves very low on-state resistance combined with high trans conductance. HEXFET transistors also feature all of the well-established advantages of MOSFETs, such as voltage control, very fast switching, ease of paralleling and electrical parameter temperature stability. They are well-suited for applications such as switching power supplies, motor controls, inverters, choppers, audio amplifiers, high energy pulse circuits, and virtually any application where high reliability is required. The HEXFET transistor's totally isolated package eliminates the need for additional isolating material between the device and the heat sink. This improves thermal efficiency and reduces drain capacitance.

Features

- Simple Drive Requirements
- Hermetically Sealed
- Electrically Isolated
- Dynamic dv/dt Rating
- Light Weight

Absolute Maximum Ratings

Symbol	Parameter	Value	Units
$I_{D1} @ V_{GS} = 10V, T_C = 25^\circ C$	Continuous Drain Current	35*	A
$I_{D2} @ V_{GS} = 10V, T_C = 100^\circ C$	Continuous Drain Current	35*	
$I_{DM} @ T_C = 25^\circ C$	Pulsed Drain Current ①	220	
$P_D @ T_C = 25^\circ C$	Maximum Power Dissipation	150	W
	Linear Derating Factor	1.2	W/ $^\circ C$
V_{GS}	Gate-to-Source Voltage	± 20	V
E_{AS}	Single Pulse Avalanche Energy ②	480	mJ
I_{AR}	Avalanche Current ①	35	A
E_{AR}	Repetitive Avalanche Energy ①	15	mJ
dv/dt	Peak Diode Recovery dv/dt ③	4.5	V/ns
T_J T_{STG}	Operating Junction and Storage Temperature Range	-55 to + 150	$^\circ C$
	Lead Temperature	300 (0.063 in. /1.6 mm from case for 10s)	
	Weight	9.3 (Typical)	g

* Current is limited by package
For Footnotes refer to the page 2.

Electrical Characteristics @ $T_J = 25^\circ\text{C}$ (Unless Otherwise Specified)

Symbol	Parameter	Min.	Typ.	Max.	Units	Test Conditions
BV_{DSS}	Drain-to-Source Breakdown Voltage	60	—	—	V	$V_{GS} = 0V, I_D = 1.0mA$
$\Delta BV_{DSS}/\Delta T_J$	Breakdown Voltage Temp. Coefficient	—	0.68	—	V/°C	Reference to $25^\circ\text{C}, I_D = 1.0mA$
$R_{DS(on)}$	Static Drain-to-Source On-State Resistance	—	—	0.027	Ω	$V_{GS} = 10V, I_{D2} = 35A$ ④
$V_{GS(th)}$	Gate Threshold Voltage	2.0	—	4.0	V	$V_{DS} = V_{GS}, I_D = 250\mu A$
G_{fs}	Forward Transconductance	20	—	—	S	$V_{DS} = 15V, I_{D2} = 35A$ ④
I_{DSS}	Zero Gate Voltage Drain Current	—	—	25	μA	$V_{DS} = 48V, V_{GS} = 0V$
		—	—	250		$V_{DS} = 48V, V_{GS} = 0V, T_J = 125^\circ\text{C}$
I_{GSS}	Gate-to-Source Leakage Forward	—	—	100	nA	$V_{GS} = 20V$
	Gate-to-Source Leakage Reverse	—	—	-100		$V_{GS} = -20V$
Q_G	Total Gate Charge	—	—	180	nC	$I_{D1} = 35A$
Q_{GS}	Gate-to-Source Charge	—	—	45		$V_{DS} = 30V$
Q_{GD}	Gate-to-Drain ('Miller') Charge	—	—	105		$V_{GS} = 10V$
$t_{d(on)}$	Turn-On Delay Time	—	—	33	ns	$V_{DD} = 30V$
t_r	Rise Time	—	—	180		$I_{D1} = 35A$
$t_{d(off)}$	Turn-Off Delay Time	—	—	100		$R_G = 2.35\Omega$
t_f	Fall Time	—	—	100		$V_{GS} = 10V$
$L_S + L_D$	Total Inductance	—	6.8	—	nH	Measured from Drain lead (6mm / 0.25 in from package) to Source lead (6mm/0.25 in from package) with Source wire internally bonded from Source pin to Drain pad
C_{iss}	Input Capacitance	—	4600	—	pF	$V_{GS} = 0V$
C_{oss}	Output Capacitance	—	2000	—		$V_{DS} = 25V$
C_{riss}	Reverse Transfer Capacitance	—	340	—		$f = 1.0MHz$

Source-Drain Diode Ratings and Characteristics

Symbol	Parameter	Min.	Typ.	Max.	Units	Test Conditions
I_S	Continuous Source Current (Body Diode)	—	—	35*	A	
I_{SM}	Pulsed Source Current (Body Diode) ①	—	—	220		
V_{SD}	Diode Forward Voltage	—	—	2.5	V	$T_J = 25^\circ\text{C}, I_S = 35A, V_{GS} = 0V$ ④
t_{rr}	Reverse Recovery Time	—	—	280	ns	$T_J = 25^\circ\text{C}, I_F = 35A, V_{DD} \leq 50V$
Q_{rr}	Reverse Recovery Charge	—	—	2.2	μC	$di/dt = 100A/\mu s$ ④
t_{on}	Forward Turn-On Time	Intrinsic turn-on time is negligible (turn-on is dominated by $L_S + L_D$)				

* Current is limited by package

Thermal Resistance

Symbol	Parameter	Min.	Typ.	Max.	Units
$R_{\theta JC}$	Junction-to-Case	—	—	0.83	°C/W
$R_{\theta CS}$	Case -to-Sink	—	0.21	—	
$R_{\theta JA}$	Junction-to-Ambient (Typical socket mount)	—	—	48	

Footnotes:

- ① Repetitive Rating; Pulse width limited by maximum junction temperature.
- ② $V_{DD} = 25V$, starting $T_J = 25^\circ\text{C}$, $L = 0.78mH$, Peak $I_L = 35A$, $V_{GS} = 10V$
- ③ $I_{SD} \leq 35A$, $di/dt \leq 200A/\mu s$, $V_{DD} \leq 60V$, $T_J \leq 150^\circ\text{C}$
- ④ Pulse width $\leq 300 \mu s$; Duty Cycle $\leq 2\%$.

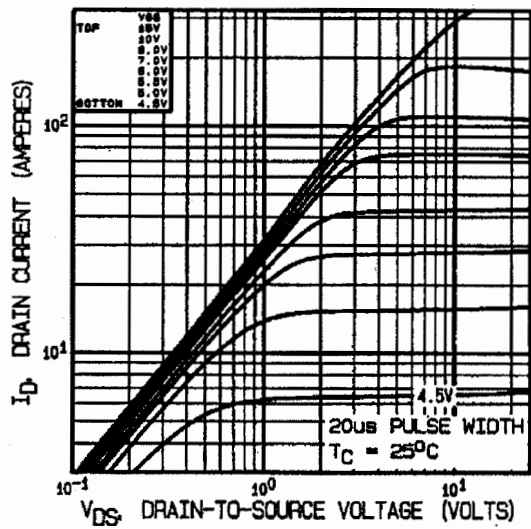

Fig 1. Typical Output Characteristics

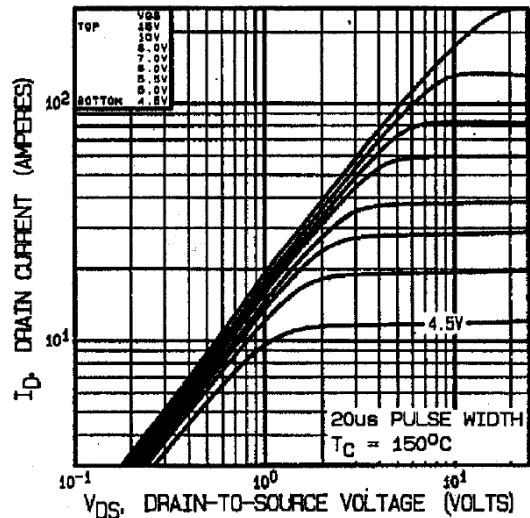

Fig 2. Typical Output Characteristics

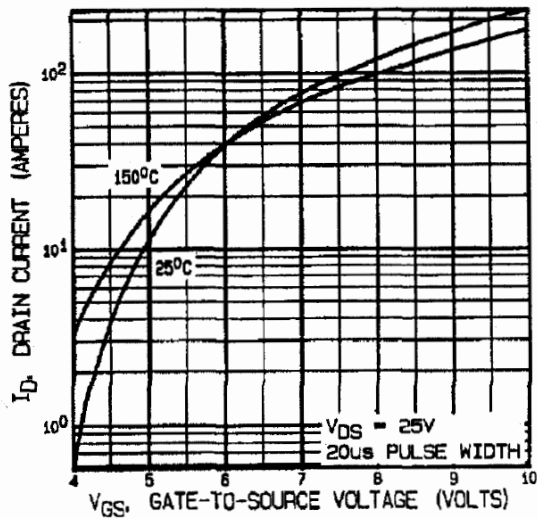

Fig 3. Typical Transfer Characteristics

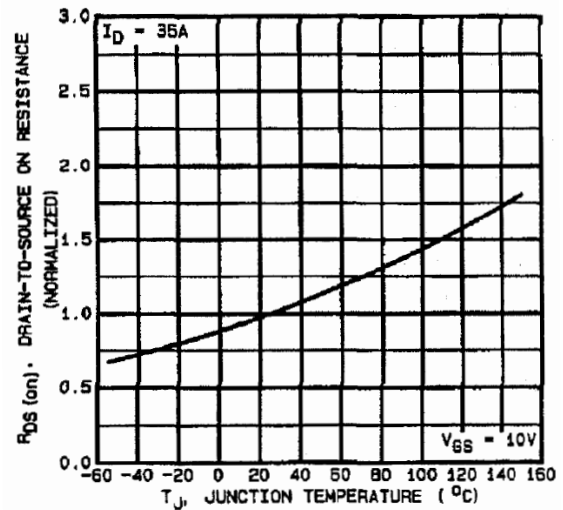

Fig 4. Normalized On-Resistance Vs. Temperature

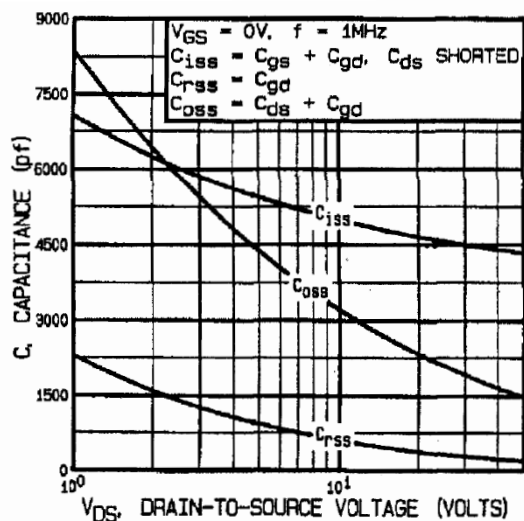

Fig 5. Typical Capacitance Vs. Drain-to-Source Voltage

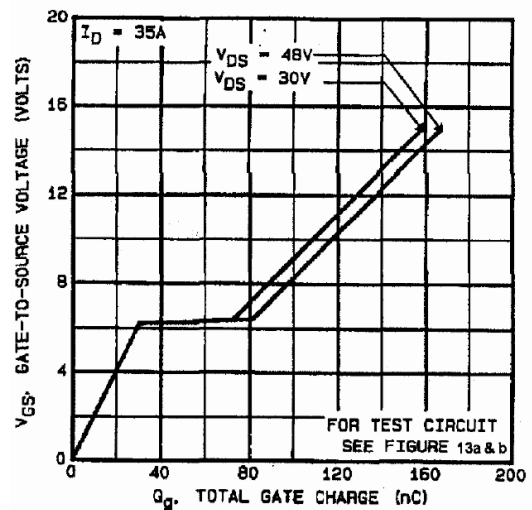

Fig 6. Typical Gate Charge Vs. Gate-to-Source Voltage

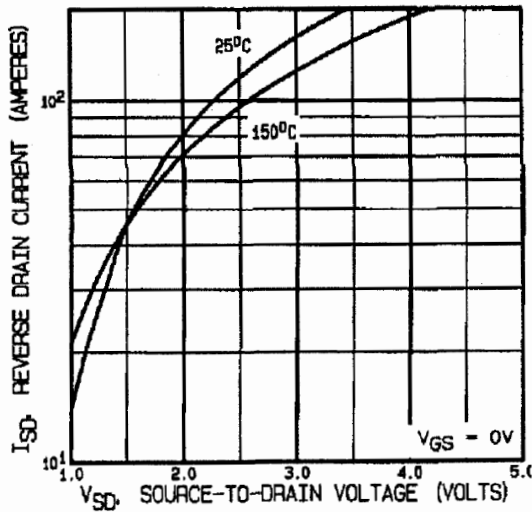

Fig 7. Typical Source-Drain Diode Forward Voltage

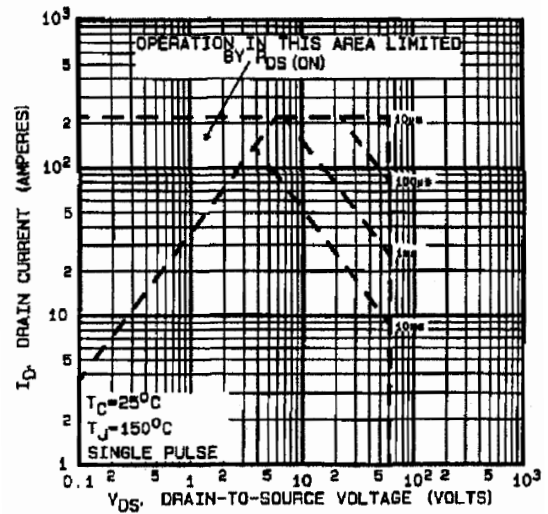

Fig 8. Maximum Safe Operating Area

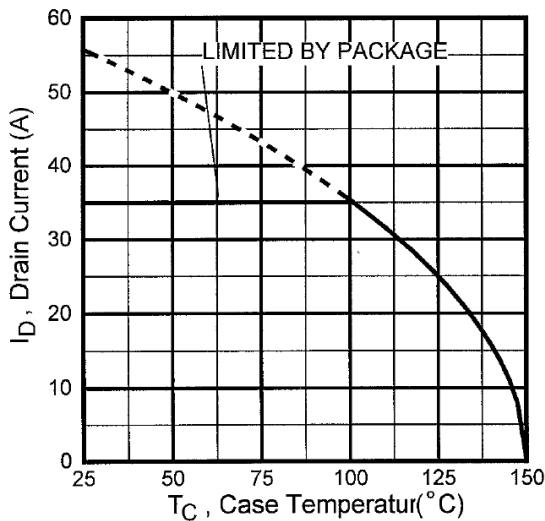

Fig 9. Maximum Drain Current Vs. Case Temperature

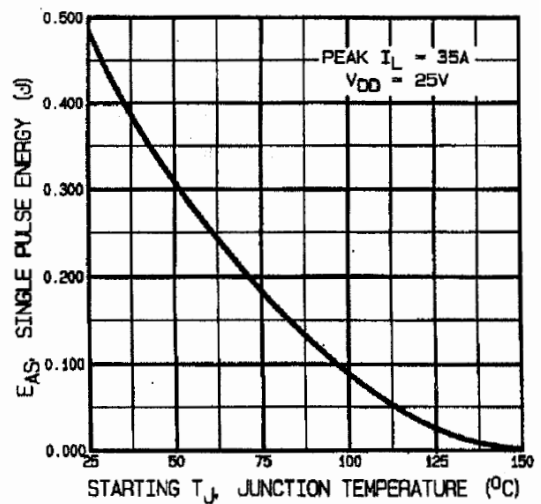

Fig 10. Maximum Avalanche Energy Vs. Drain Current

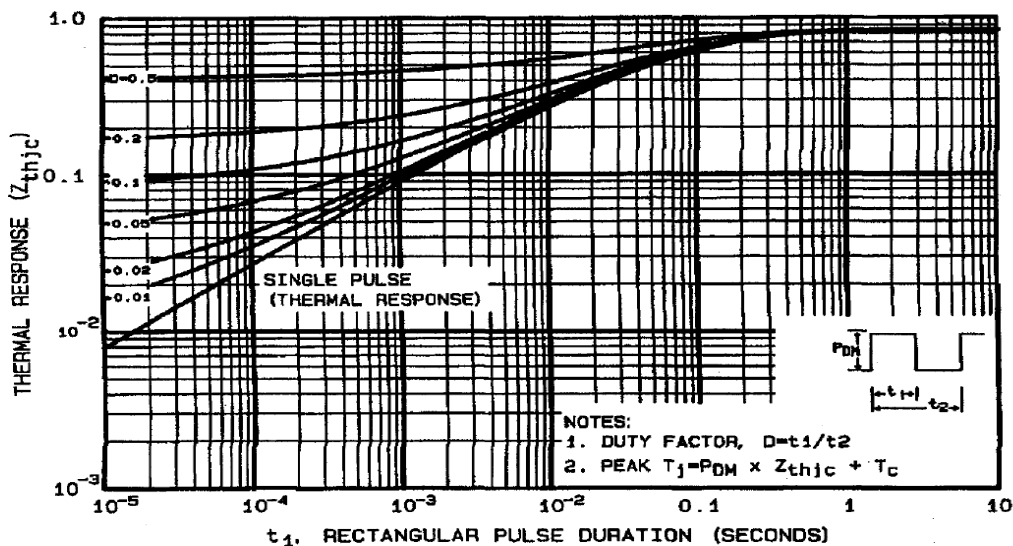

Fig 11. Maximum Effective Transient Thermal Impedance, Junction-to-Case

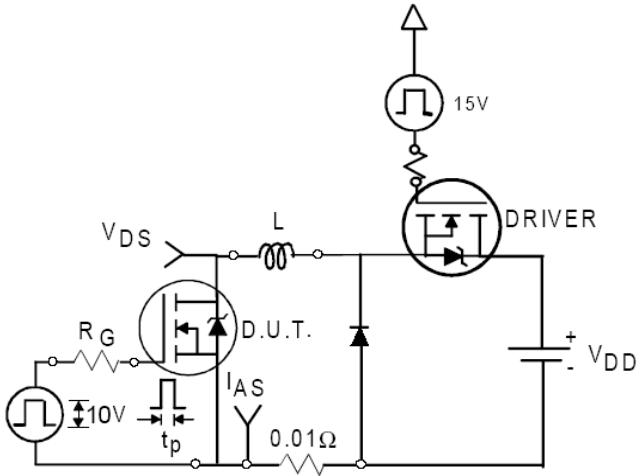

Fig 12a. Unclamped Inductive Test Circuit

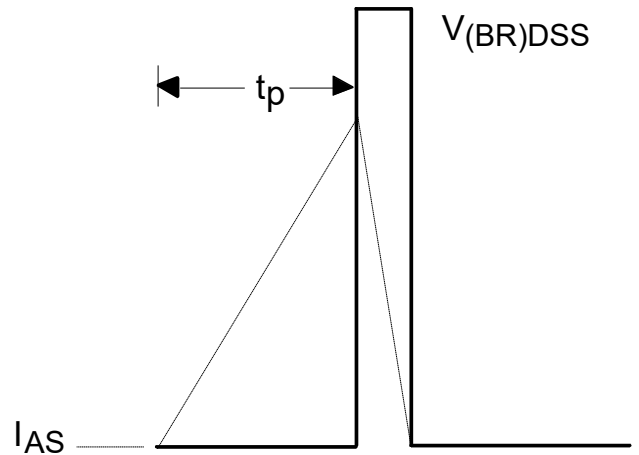

Fig 12b. Unclamped Inductive Waveforms

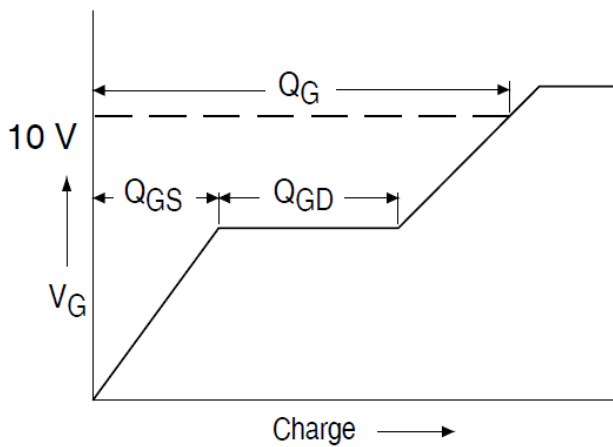

Fig 13a. Basic Gate Charge Waveform

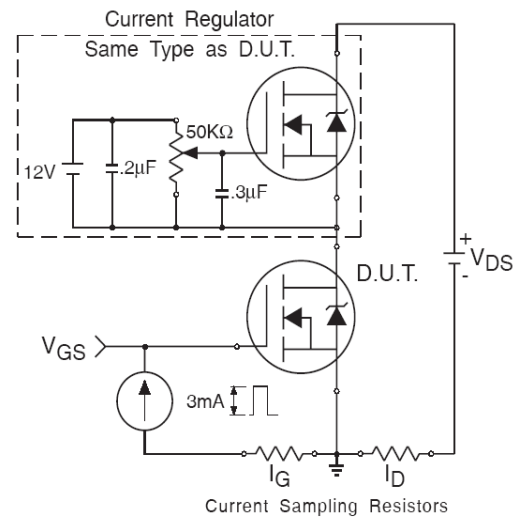

Fig 13b. Gate Charge Test Circuit

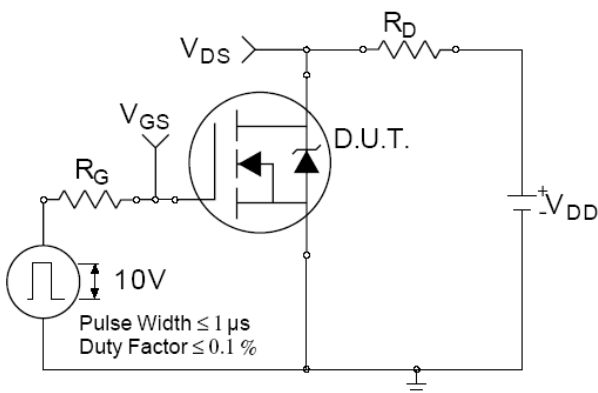

Fig 14a. Switching Time Test Circuit

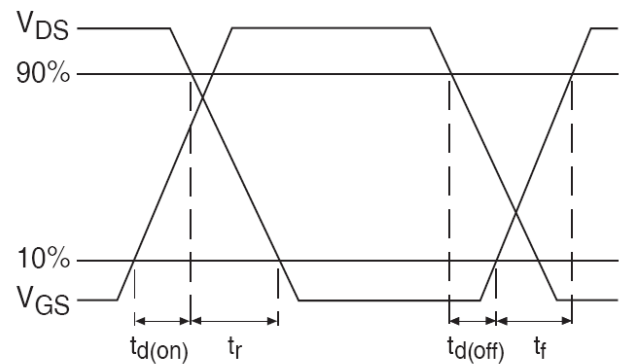
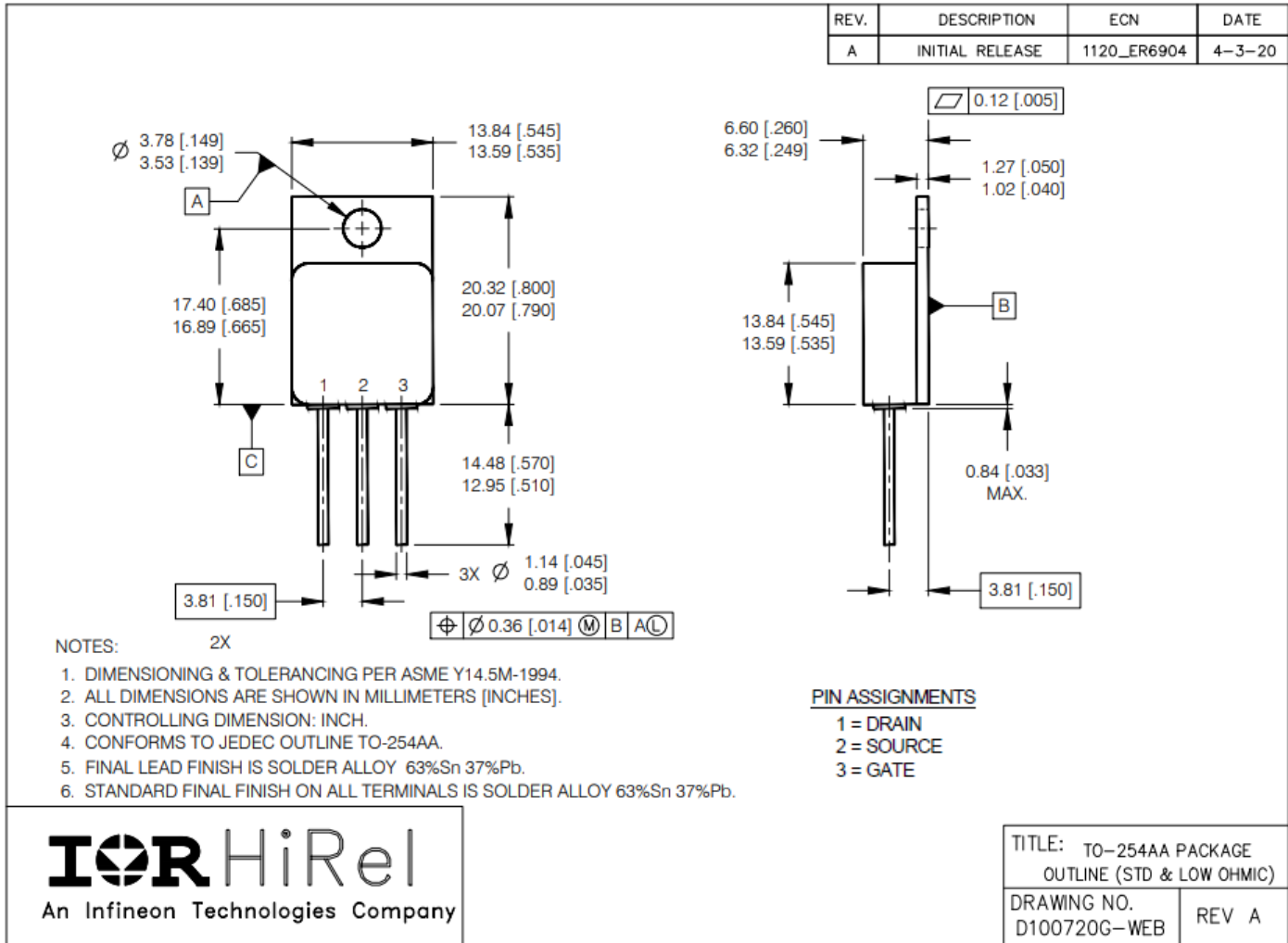

Fig 14b. Switching Time Waveforms

Note: For the most updated package outline, please see the website: TO-254AA

Case Outline and Dimensions - Low-Ohmic TO-254AA



BERYLLIA WARNING PER MIL-PRF-19500

Package containing beryllia shall not be ground, sandblasted, machined, or have other operations performed on them which will produce beryllia or beryllium dust. Furthermore, beryllium oxide packages shall not be placed in acids that will produce fumes containing beryllium.

IMPORTANT NOTICE

The information given in this document shall be in no event regarded as guarantee of conditions or characteristic. The data contained herein is a characterization of the component based on internal standards and is intended to demonstrate and provide guidance for typical part performance. It will require further evaluation, qualification and analysis to determine suitability in the application environment to confirm compliance to your system requirements.

With respect to any example hints or any typical values stated herein and/or any information regarding the application of the product, Infineon Technologies hereby disclaims any and all warranties and liabilities of any kind including without limitation warranties on non- infringement of intellectual property rights and any third party.

In addition, any information given in this document is subject to customer's compliance with its obligations stated in this document and any applicable legal requirements, norms and standards concerning customer's product and any use of the product of Infineon Technologies in customer's applications.

The data contained in this document is exclusively intended for technically trained staff. It is the responsibility of any customer's technical departments to evaluate the suitability of the product for the intended applications and the completeness of the product information given in this document with respect to applications.

For further information on the product, technology, delivery terms and conditions and prices, please contact your local sales representative or go to (www.infineon.com/hirel).

WARNING

Due to technical requirements products may contain dangerous substances. For information on the types in question, please contact your nearest Infineon Technologies office.