

**HEXFRED
ULTRAFast, SOFT RECOVERY DIODE**

$V_R = 200V$
$I_{F(AV)} = 60A$
$t_{rr} = 50ns$

Features

- Reduced RFI and EMI
- Reduced Snubbing
- Extensive Characterization of Recovery Parameters
- Hermetically Sealed
- Surface Mount

Description

These Ultrafast, soft recovery diodes are optimized to reduce losses and EMI/RFI in high frequency power conditioning systems. An extensive characterization of the recovery behavior for different values of current, temperature and di/dt simplifies the calculations of losses in the operating conditions. The softness of the recovery eliminates the need for a snubber in most applications. These devices are ideally suited for power converters, motors drives and other applications where switching losses are significant portion of the total losses.

Absolute Maximum Ratings

Characteristics	Parameter	Max.	Units
V_R	Cathode to Anode Voltage	200	V
$I_{F(AV)}$	Continuous Forward Current, $T_C = 55^\circ C$ ①	60	A
I_{FSM}	Single Pulse Forward Current, $T_C = 25^\circ C$ ②	500	A
$P_D @ T_C = 25^\circ C$	Maximum Power Dissipation	70	W
T_J, T_{STG}	Operating Junction and Storage Temperature Range	-55 to 150	$^\circ C$

Notes:

- ① D.C. = 50% rectangle wave
- ② 1/2 sine wave, 60Hz, Pulse Width = 8.33ms

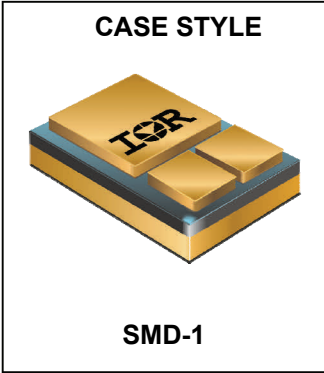
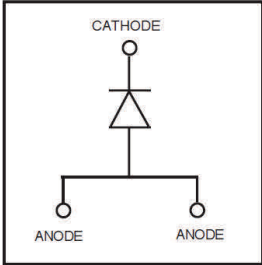
<p>CASE STYLE</p>  <p>SMD-1</p>	<p>PIN ASSIGNMENTS</p> 
--	--

Electrical Characteristics @ $T_J = 25^\circ\text{C}$ (unless otherwise specified)

Symbol	Parameter	Min.	Typ.	Max.	Units	Test Conditions
V_{BR}	Cathode Anode Breakdown Voltage	200	—	—	V	$I_R = 100\mu\text{A}$
V_{FM}	Max Forward Voltage See Fig. 1	—	—	1.15	V	$I_F = 30\text{A}, T_J = -55^\circ\text{C}$
		—	—	0.97		$I_F = 30\text{A}, T_J = 25^\circ\text{C}$
		—	—	1.08		$I_F = 60\text{A}, T_J = 25^\circ\text{C}$
		—	—	1.30		$I_F = 120\text{A}, T_J = 25^\circ\text{C}$
		—	—	0.8		$I_F = 30\text{A}, T_J = 125^\circ\text{C}$
I_{RM}	Max Reverse Leakage Current See Fig. 2	—	—	50	μA	$V_R = V_R \text{ Rated}$
		—	—	1.0	mA	$V_R = V_R \text{ Rated}, T_J = 125^\circ\text{C}$
C_T	Junction Capacitance, See Fig. 3	—	—	200	pF	$V_R = 200\text{V}$
L_S	Series Inductance	—	5.9	—	nH	Measured from center of cathode pad to center of anode pad

Dynamic Recovery Characteristics @ $T_J = 25^\circ\text{C}$ (unless otherwise specified)

Symbol	Parameter	Min.	Typ.	Max.	Units	Test Conditions	
t_{rr1}	Reverse Recovery Time See Fig. 5	—	45	50	ns	$T_J = 25^\circ\text{C}$	$I_F = 60\text{A}$ $V_R = 160\text{V}$ $di_f/dt = 200\text{A}/\mu\text{s}$
t_{rr2}		—	71	—		$T_J = 125^\circ\text{C}$	
I_{RRM1}	Peak Recovery Current See Fig. 6	—	5.3	—	A	$T_J = 25^\circ\text{C}$	
I_{RRM2}		—	10.3	—		$T_J = 125^\circ\text{C}$	
Q_{rr1}	Reverse Recovery Charge See Fig. 7	—	120	—	nC	$T_J = 25^\circ\text{C}$	
Q_{rr2}		—	366	—		$T_J = 125^\circ\text{C}$	
$di_{(rec)M}/dt1$	Peak Rate of Fall of Recovery Current	—	590	—	$\text{A}/\mu\text{s}$	$T_J = 25^\circ\text{C}$	
$di_{(rec)M}/dt1$	During t_b - See Fig. 8	—	1290	—		$T_J = 125^\circ\text{C}$	

Thermal - Mechanical Characteristics

Symbol	Parameter	Typ.	Max.	Units
$R_{\theta JC}$	Junction-to-Case, See Fig. 4	—	1.76	$^\circ\text{C}/\text{W}$
Wt	Weight	2.6	—	g

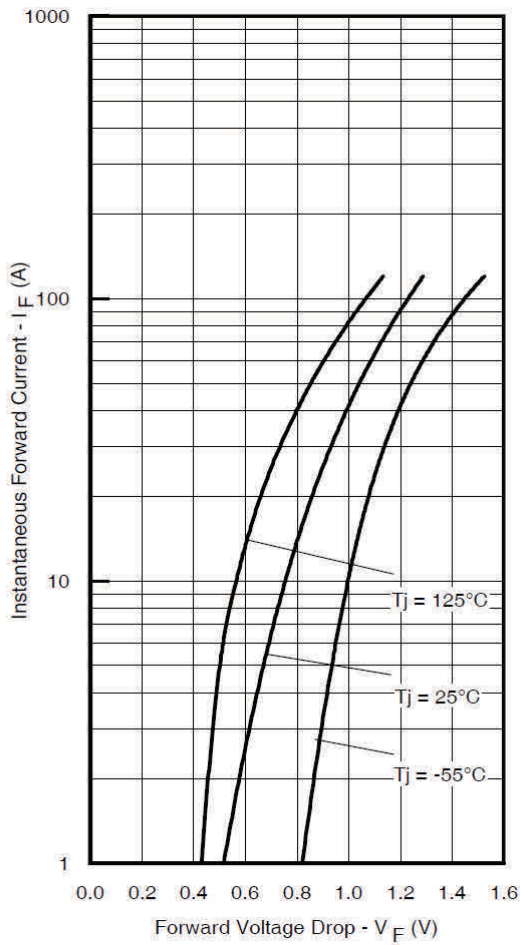

Fig. 1 Maximum Forward Voltage Drop Vs. Instantaneous Forward Current

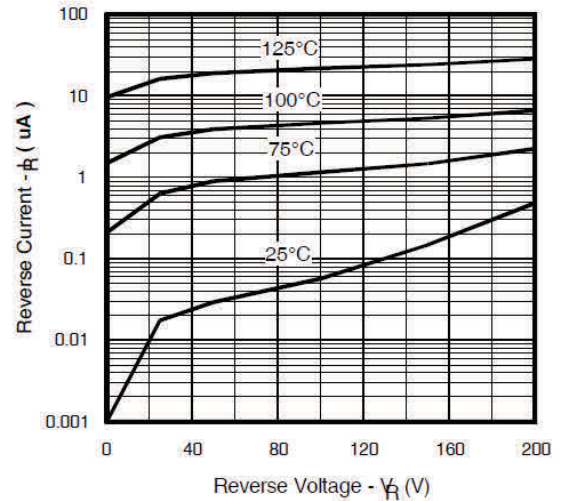

Fig. 2 Typical Values of Reverse Current Vs. Reverse Voltage

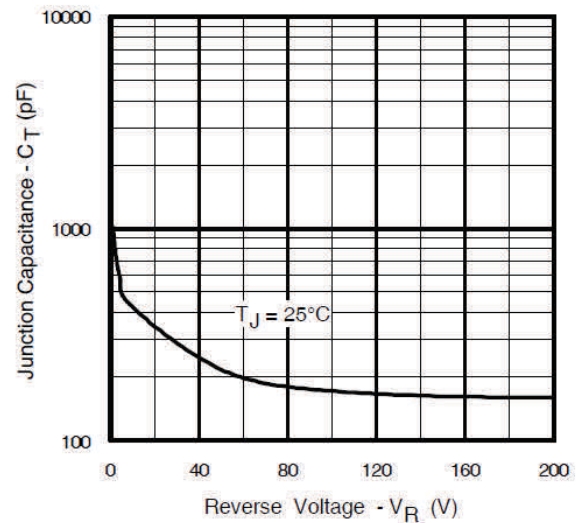

Fig. 3 Typical Junction Capacitance Vs. Reverse Voltage

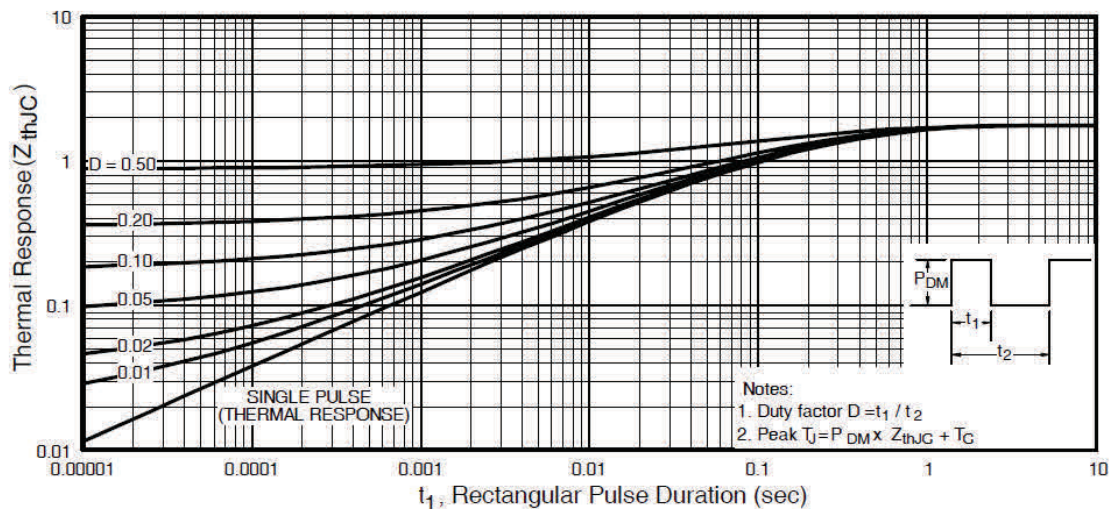

Fig. 4 Max. Thermal Impedance Z_{thJC} Characteristics

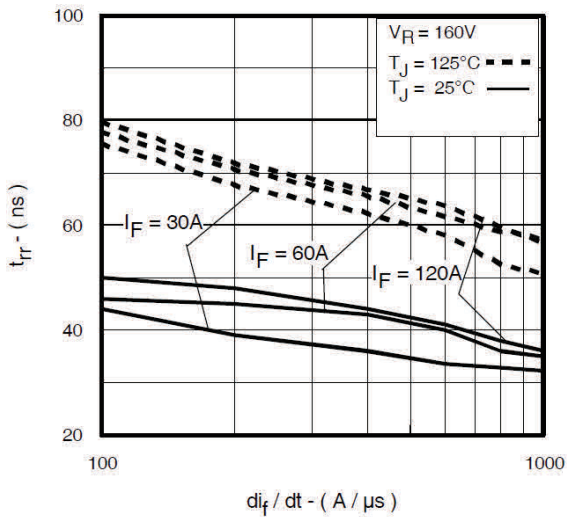

Fig. 5 Typical Reverse Recovery Vs di_f/dt

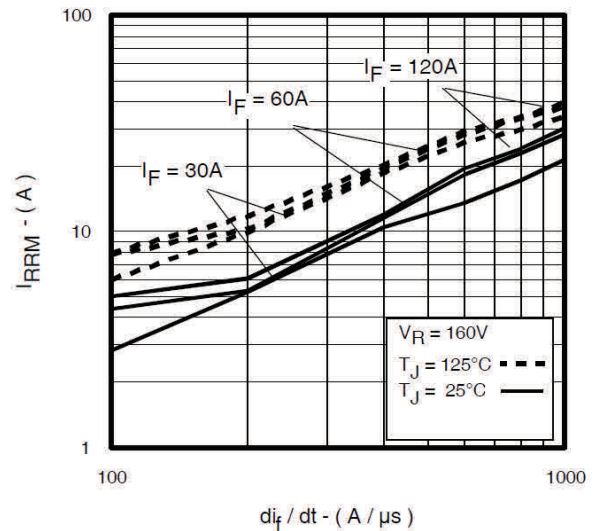

Fig. 6 Typical Recovery Current Vs di_f/dt

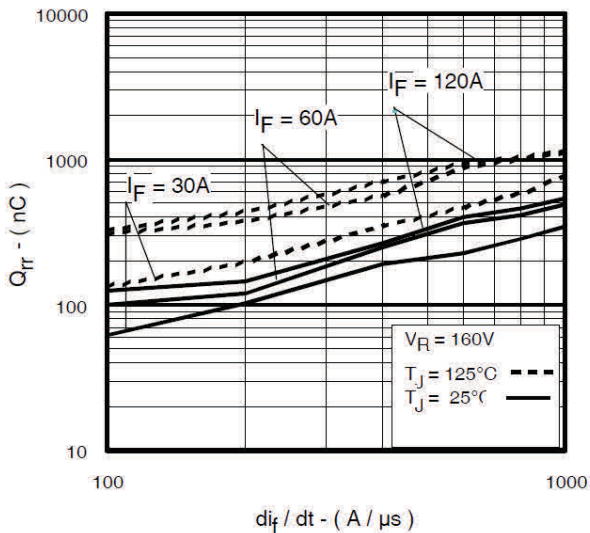

Fig. 7 Typical Stored Charge Vs di_f/dt

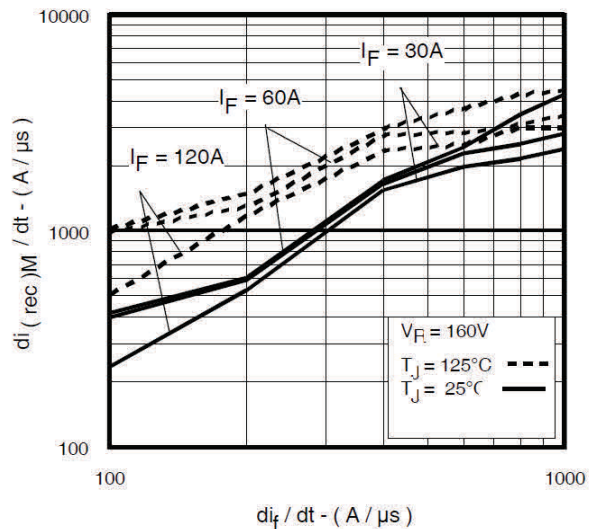

Fig. 8 Typical $di_{(rec)M}/dt$ Vs di_f/dt

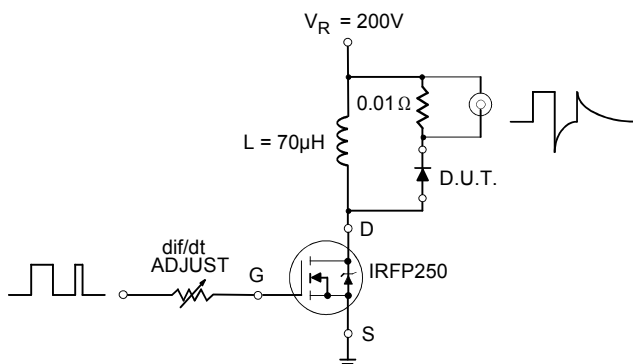
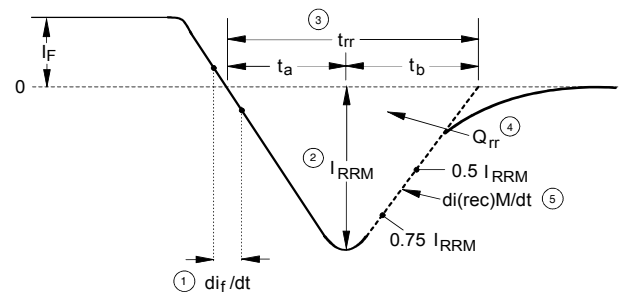

Fig. 9 Typical Reverse Recovery Parameter Test Circuit



- ① di_f/dt - Rate of change of current through zero crossing.
- ② I_{RRM} - Peak reverse recovery current.
- ③ t_{rr} - Reverse recovery time measured from zero crossing point of negative going I_F to point where a line passing through $0.75I_{RRM}$ and $0.5I_{RRM}$ extrapolated to zero current.
- ④ Q_{rr} - Area under curve defined by t_{rr} and I_{RRM} - $Q_{rr} = (t_{rr} \times I_{RRM}) / 2$
- ⑤ $di_{(rec)M}/dt$ - Peak rate of change of current during t_b position of t_{rr} .

Fig. 10 Reverse Recovery Waveform and Definitions

Case Outline and Dimensions — SMD-1

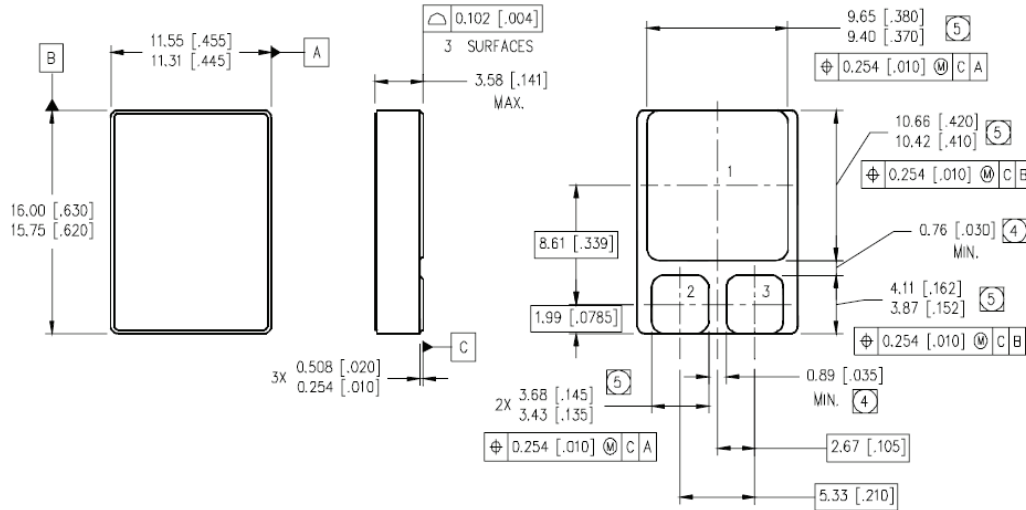

NOTES:

1. DIMENSIONING & TOLERANCING PER ASME Y14.5M-1994.
2. CONTROLLING DIMENSION: INCH.
3. DIMENSIONS ARE SHOWN IN MILLIMETERS [INCHES].
4. DIMENSION INCLUDES METALLIZATION FLASH.
5. DIMENSION DOES NOT INCLUDE METALLIZATION FLASH.

PAD ASSIGNMENTS

- 1 = CATHODE
- 2 = COMMON ANODE
- 3 = COMMON ANODE

IMPORTANT NOTICE

The information given in this document shall be in no event regarded as guarantee of conditions or characteristic. The data contained herein is a characterization of the component based on internal standards and is intended to demonstrate and provide guidance for typical part performance. It will require further evaluation, qualification and analysis to determine suitability in the application environment to confirm compliance to your system requirements.

With respect to any example hints or any typical values stated herein and/or any information regarding the application of the product, Infineon Technologies hereby disclaims any and all warranties and liabilities of any kind including without limitation warranties on non- infringement of intellectual property rights and any third party.

In addition, any information given in this document is subject to customer's compliance with its obligations stated in this document and any applicable legal requirements, norms and standards concerning customer's product and any use of the product of Infineon Technologies in customer's applications.

The data contained in this document is exclusively intended for technically trained staff. It is the responsibility of any customer's technical departments to evaluate the suitability of the product for the intended applications and the completeness of the product information given in this document with respect to applications.

For further information on the product, technology, delivery terms and conditions and prices, please contact your local sales representative or go to (www.infineon.com/hirel).

WARNING

Due to technical requirements products may contain dangerous substances. For information on the types in question, please contact your nearest Infineon Technologies office.