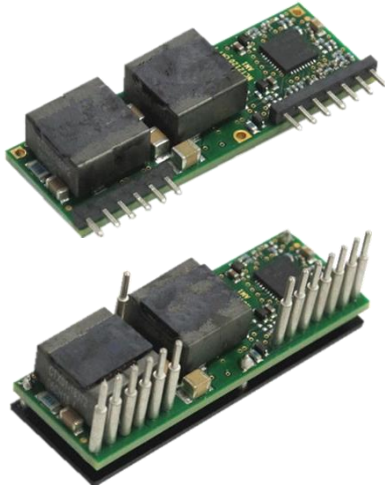


0.8-5.5V 60A Point-of Load Converter



Features

- Efficiency up to 95.0% (5V/60A)
- Excellent thermal performance
- Output over-voltage, over-current, short-circuit and over-temperature protections
- Monotonic start-up into pre-biased load
- Fixed frequency operation
- UL 60950-1 2nd edition recognized[†]

Options

- Baseplate
- Negative / Positive enable logic
- Frequency synchronization / Power good / Sense-
- Output voltage tracking / Sequencing

Part Numbering System

NCT	1	000	□	060	□	□	□	□
Series Name	Input Voltage	Output Voltage	Enabling Logic	Rated Output Current	Pin Options	Option 1	Mechanical Options	Option 2
	1: 8-16V	000: Variable*	P: Positive N: Negative	Unit: A 060: 60A	H: Horizontal (0.18") R: Vertical (0.13") T: Vertical (0.17")	0: None 1: Voltage tracking	5: Open frame 6: Baseplate	0: None 1: Frequency synchronization 2: Power good 3: Sense-

* Consult the factory for semi-custom codes with the output voltage set to a specific value without using an external programming resistor.

[†] UL is a registered trademark of Underwriters Laboratory Inc.

Absolute Maximum Rating

Excessive stresses over these absolute maximum ratings can cause permanent damage to the converter. Operation should be limited to the conditions outlined under the Electrical Specification Section.

Parameter	Min	Max	Unit
Input Voltage (continuous)	-0.5	22	Vdc
Operating Ambient Temperature (See Thermal Considerations section)	-40	85*	°C
Storage Temperature	-55	125	°C

*Derating curves provided in this datasheet end at 85°C ambient temperature. Operation above 85°C ambient temperature is allowed provided the temperatures of the key components or the baseplate do not exceed the limit stated in the Thermal Considerations section.

Electrical Specifications

These specifications are valid over the converter's full range of input voltage, resistive load, and temperature unless noted otherwise.

Parameter	Min	Typical	Max	Unit
Input Specifications				
Input Voltage	8	12	16	Vdc
Input Current	-	-	40	A
Quiescent Input Current (typical Vin)	-	220	280	mA
Standby Input Current	-	22	-	mA
Input Reflected-ripple Current, peak-to-peak (5-20 MHz, 12µH source impedance)	-	20	-	mA
Input Turn-on Voltage Threshold	-	7.5	8.0	V
Input Voltage ON/OFF Hysteresis	-	0.1	-	V
Output Specifications				
Output Voltage Set Point Accuracy (typical Vin; full load; Ta = 25°C)	-2.0	-	+2.0	%Vo
Output Voltage Set Point Accuracy (over all conditions)	-2.5	-	+3.5	%Vo
Output Regulation:				
Line Regulation (full range input voltage, 1/2 full load)	-	0.2	-	%Vo
Load Regulation (full range load, typical Vin)	-	0.3	-	%Vo
Temperature (Ta = -40°C to 85 °C)	-	0.2	-	%Vo
Output Ripple and Noise Voltage RMS	-	-	1	%Vo
Peak-to-peak (5 Hz to 20 MHz bandwidth, typical Vin)	-	1.5	-	%Vo
Output Current	0	-	60	A
Efficiency (typical Vin; full load; Ta = 25°C)	Vo=0.8V	-	80.5	-
	Vo=1.0V	-	83.0	-
	Vo=1.2V	-	85.0	-
	Vo=1.5V	-	86.5	-
	Vo=1.8V	-	87.5	-
	Vo=2.5V	-	90.0	-
	Vo=3.3V	-	92.0	-
	Vo=5V	-	95.0	-
Output Ripple Frequency	240	270	300	kHz

External Load Capacitance		-	-	33,000	μF
Output Over Current Protection Set Point		-	145	-	%Io
Output Over Voltage Protection Set Point		-	116	-	%Vo
Power Good	Source current	-	-	0.1	mA
	High level voltage	4.5	5.0	5.5	V
	Low level voltage	0	0.35	0.40	V
	Delay time from Vo reaches regulation point	-	5	-	ms
Dynamic Response (typical Vin; Ta = 25°C; load transient 1A/μs) Load steps from 50% to 75% of full load:					
	Peak deviation	-	200	-	mV
	Settling time (within 10% band of Vo deviation)	-	250	-	μs
Load step from 75% to 50% of full load					
	Peak deviation	-	200	-	mV
	Settling time (within 10% band of Vo deviation)	-	250	-	μs
General Specifications					
Remote Enable					
Positive Logic:					
	Logic Low (module OFF)	0	-	2.5	V
	Logic High (module ON)	5.5	-	16	V
Negative Logic:					
	Logic Low (module ON)	0	-	0.5	V
	Logic High (module OFF)	3.5	-	16	V
Calculated MTBF (Telecordia SR-332, 2011, Issue 3), full load, 40°C, 60% upper confidence level, typical Vin		-	9.8	-	10 ⁶ -hour

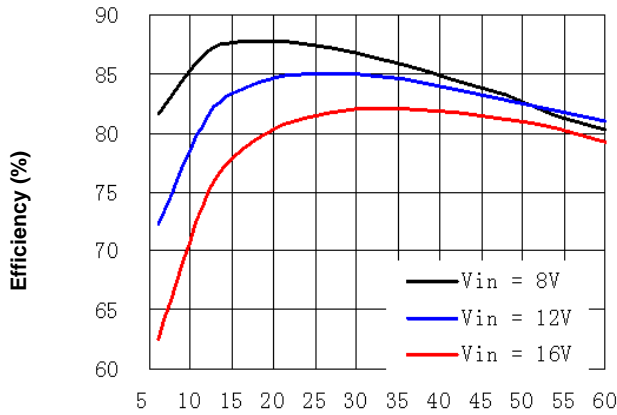
Characteristic Curves


Figure 1a. Efficiency vs. Load Current (25°C, $V_o=0.8V$)

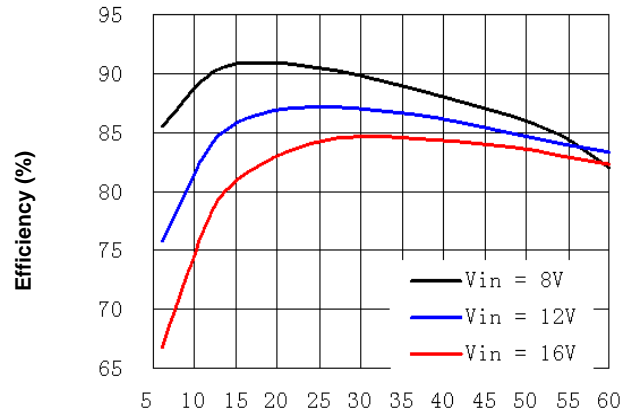


Figure 1b. Efficiency vs. Load Current (25°C, $V_o=1.0V$)

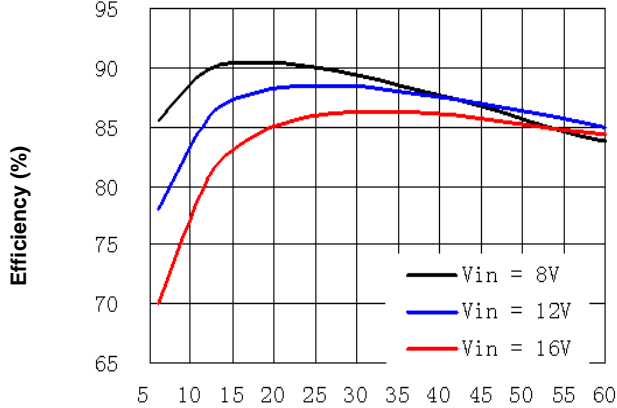


Figure 1c. Efficiency vs. Load Current (25°C, $V_o=1.2V$)

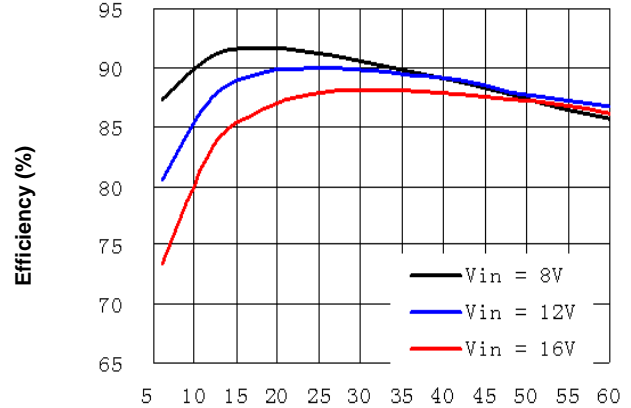


Figure 1d. Efficiency vs. Load Current (25°C, $V_o=1.5V$)

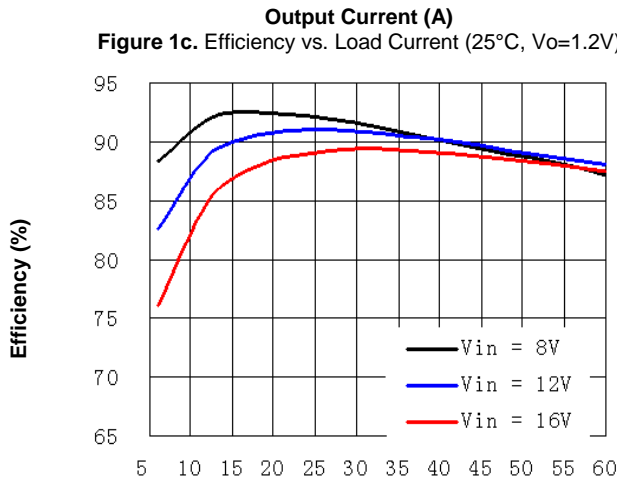


Figure 1e. Efficiency vs. Load Current (25°C, $V_o=1.8V$)

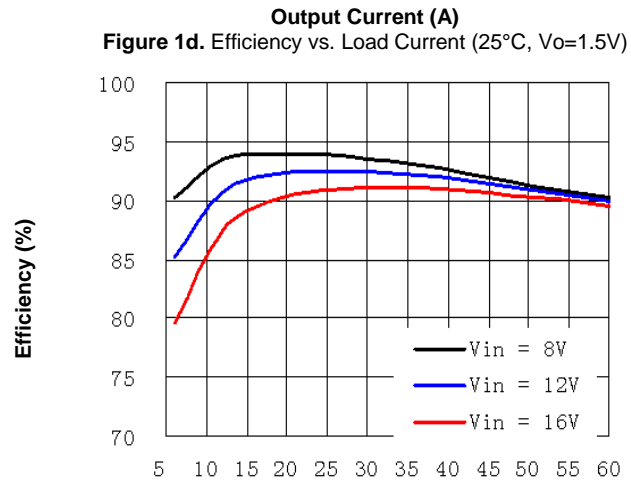
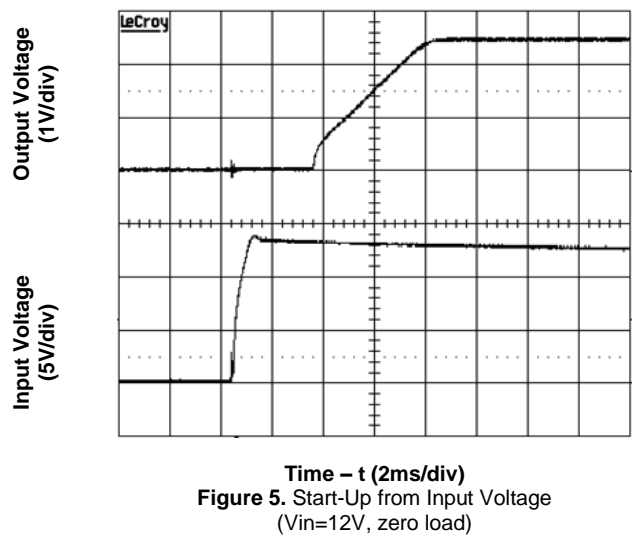
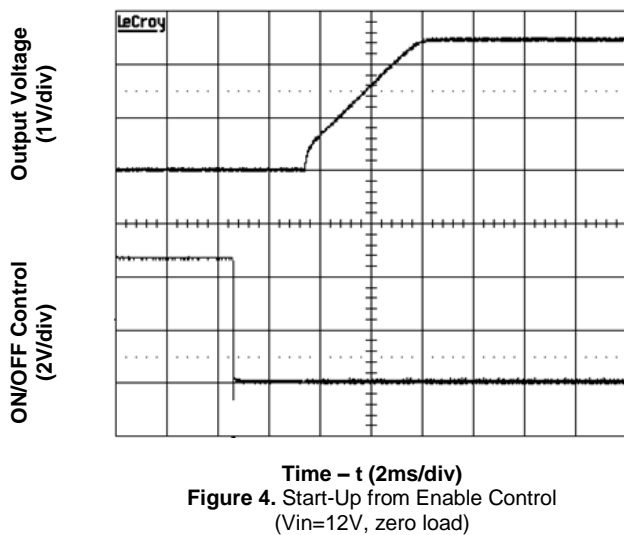
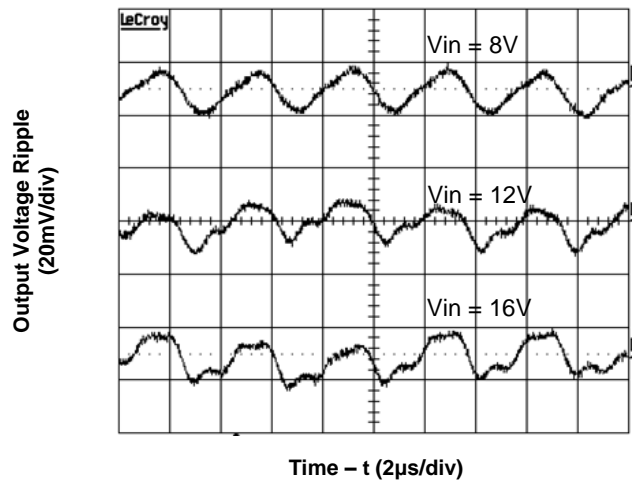
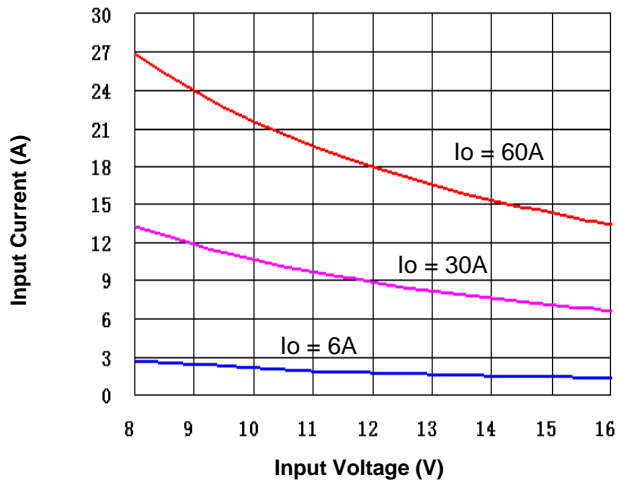
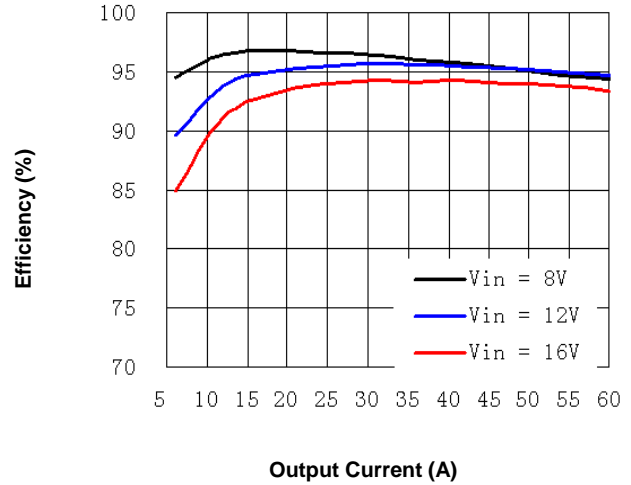
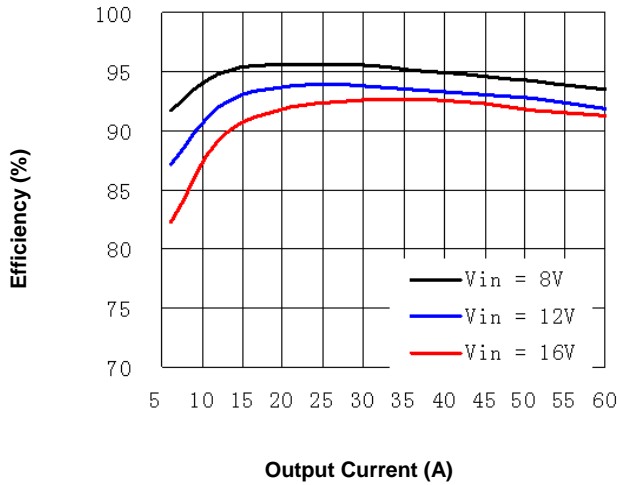
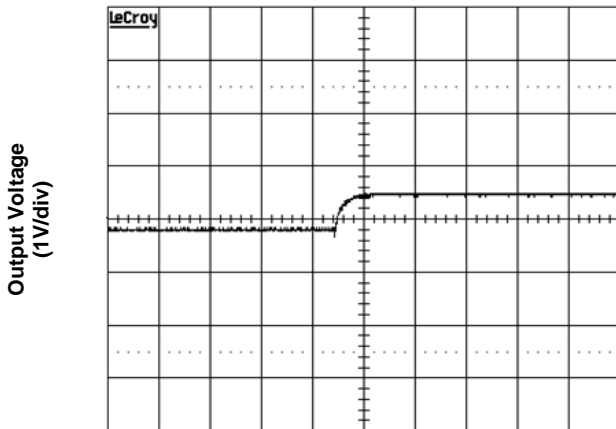
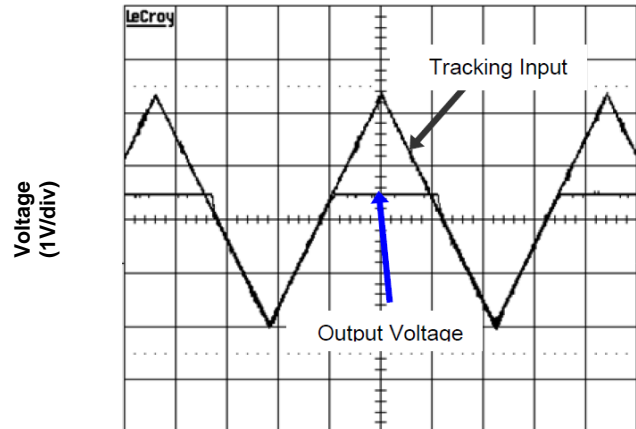


Figure 1f. Efficiency vs. Load Current (25°C, $V_o=2.5V$)

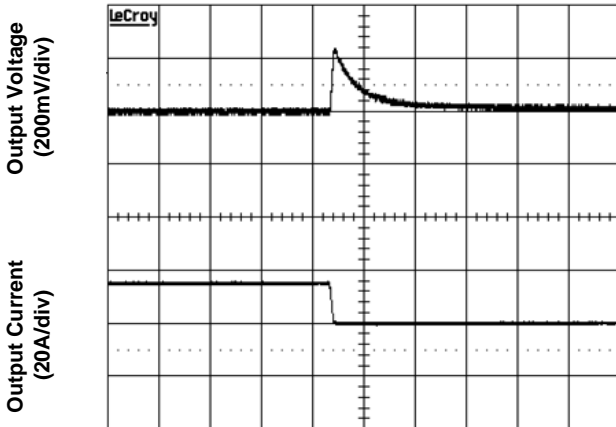




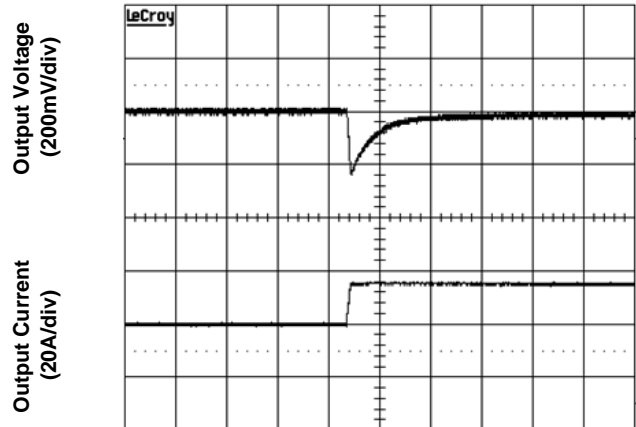
Time – t (10ms/div)

Figure 6. Start-Up with Pre-bias
 (Vin=12V, 2.5V/0A output, pre-bias voltage=1.8V)


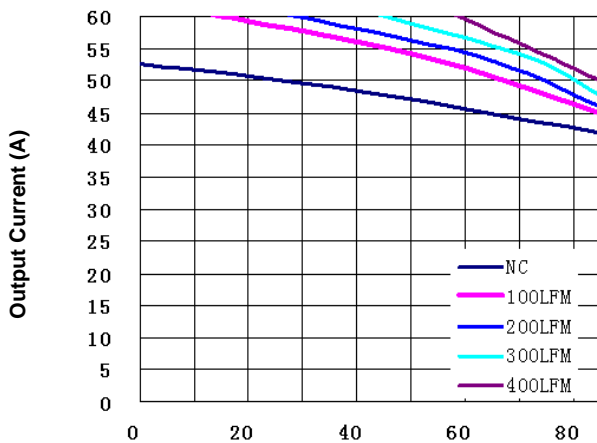
Time – t (10ms/div)

Figure 7. Voltage Tracking/Sequencing
 (voltage tracking option, Vin=12V, Vo=2.5V, Io=0A)


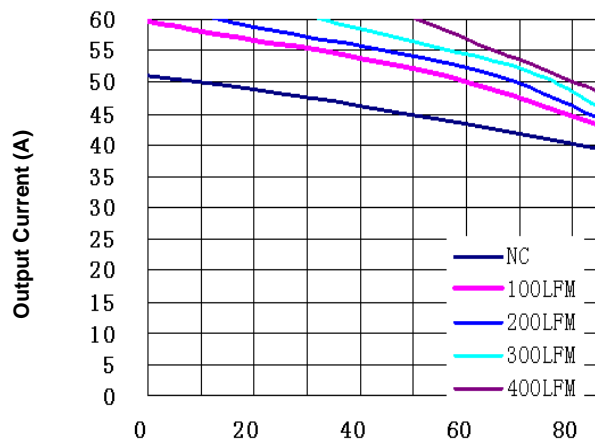
Time – t (200µs/div)

Figure 8. Transient Load Response
 (typical Vin, load current steps from 75% to 50% at a slew rate 1A/µs)


Time – t (200µs/div)

Figure 9. Transient Load Response
 ((typical Vin, load current steps from 50% to 75% at a slew rate 1A/µs)


Ambient Temperature (°C)

Figure 10a. Current Derating Curve
 (Vin=12V, Vo=0.8V, open frame)


Ambient Temperature (°C)

Figure 10b. Current Derating Curve
 (Vin=12V, Vo=1.0V, open frame)

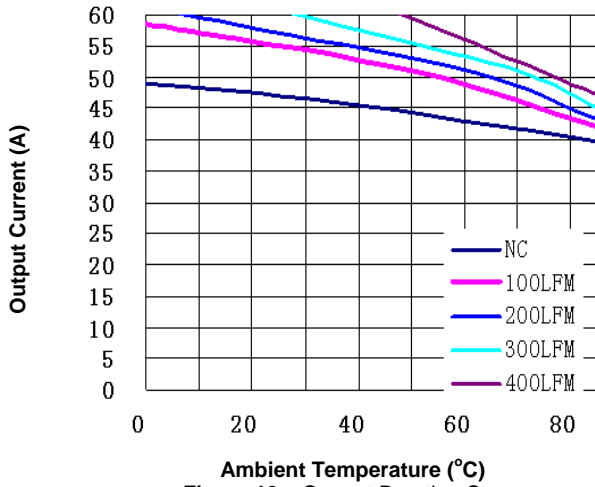


Figure 10c. Current Derating Curve
($V_{in}=12V$, $V_o=1.2V$, open frame)

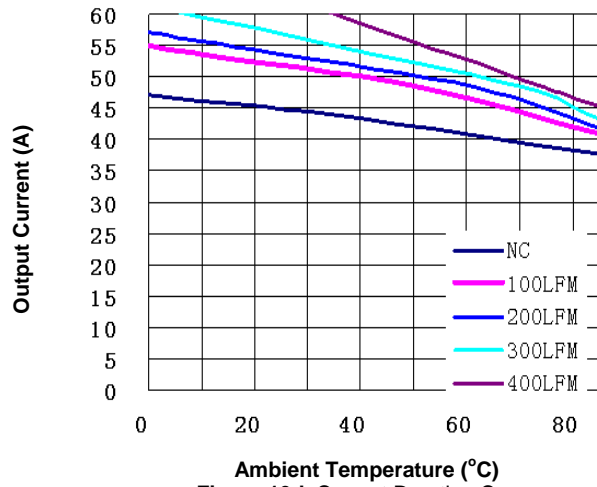


Figure 10d. Current Derating Curve
($V_{in}=12V$, $V_o=1.5V$, open frame)

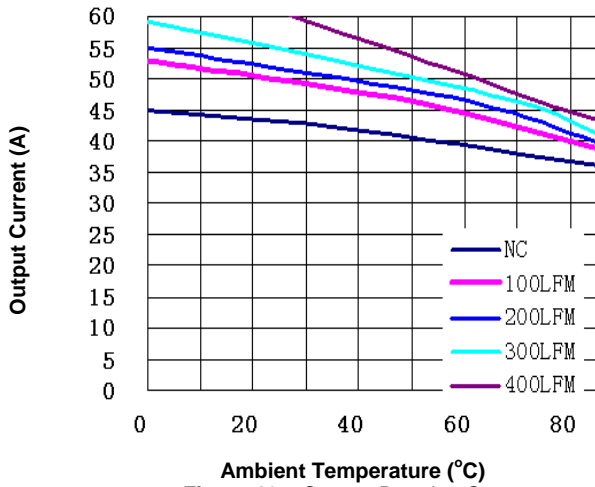


Figure 10e. Current Derating Curve
($V_{in}=12V$, $V_o=1.8V$, open frame)

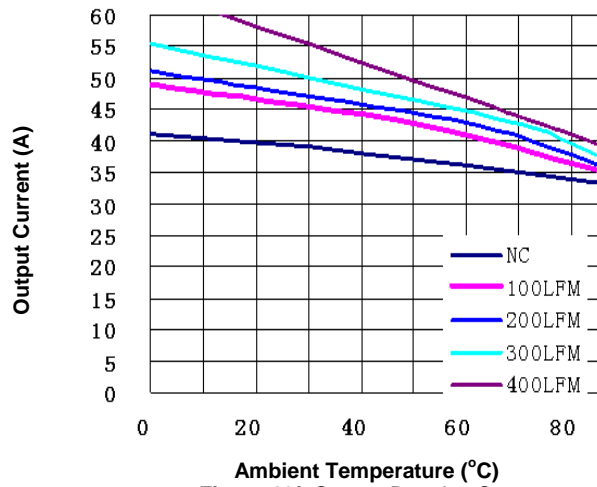


Figure 10f. Current Derating Curve
($V_{in}=12V$, $V_o=2.5V$, open frame)

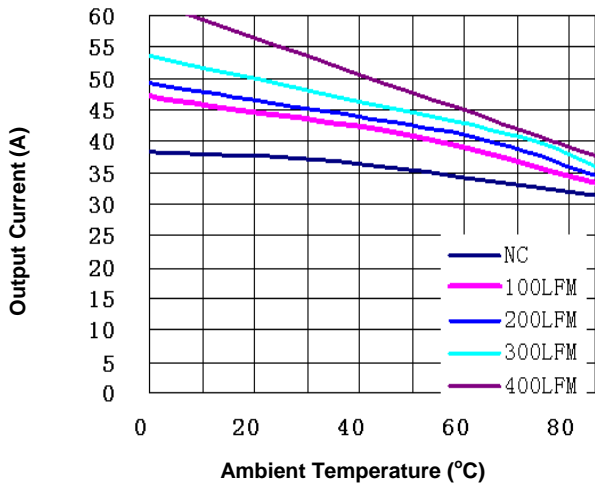


Figure 10g. Current Derating Curve
($V_{in}=12V$, $V_o=3.3V$, open frame)

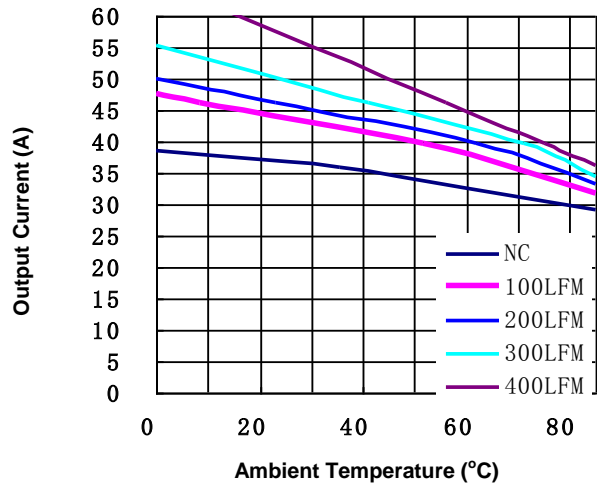


Figure 10h. Current Derating Curve
($V_{in}=12V$, $V_o=5V$, open frame)

Feature Descriptions

Remote ON/OFF

The converter can be turned on and off by changing the voltage between the ON/OFF pin and $V_{in}(-)$. The NCT series of converters are available with factory selectable positive logic and negative logic.

For the negative control logic, the converter is ON when the ON/OFF pin is at a logic low level and OFF when the ON/OFF pin is at a logic high level. For the positive control logic, the converter is ON when the ON/OFF pin is at a logic high level and OFF when the ON/OFF pin is at a logic low level. The converter is ON no matter what control logic is when ON/OFF pin is left open (unconnected).

Figure 11 is the recommended ON/Off control circuit for logic modules, both using open collector/drain circuit. Recommended value of the pull up resistor $R_{pull-up}$ is 50Kohm. The maximum allowable leakage current from this pin at logic-high level is 50 μ A.

Figure 12 shows direct logic control. When this method is used, it's important to make sure that the voltage at the ON/OFF pin is properly set for HIGH and LOW by the direct logic control circuit. For a positive logic enabling NCT module, logic HIGH requires 5.5V or higher voltage at the ON/OFF pin, and logic LOW requires 2.5V or lower voltage at the ON/OFF pin; For a negative logic enabling NCT module, logic HIGH requires 3.5V or higher voltage at the ON/OFF pin, and logic LOW requires 0.5V or lower voltage at the ON/OFF pin.

Remote SENSE

The remote SENSE pin is used to sense the voltage at the load point to accurately regulate the load voltage and eliminate the impact of the voltage drop in the power distribution path.

The SENSE pin should be connected to the point where regulation is desired. The voltage difference between the output pins must not exceed the operating range of this converter shown in the specification table.

When remote sense is not used, the SENSE pin can be connected to the positive output terminals. If the SENSE pins are left floating, the converter will deliver an output voltage slightly higher than its specified typical output voltage. The OVP (output over-voltage

protection) circuit senses the voltage across the output pins, so the total voltage rise should not exceed the minimum OVP set point given in the Specifications Table in operation.

The converter has an optional feature Sense (designated by "3" in Option 2 in the part number). If this option is ordered, Pin 7 is the negative remote sense pin, and it should be connected to the location where the ground voltage should be sensed. Without this feature, the voltage drop on the ground (common) connection is not compensated by the converter, and it is important to make sure that the connection resistance and voltage drop between GND pin and the load is small.

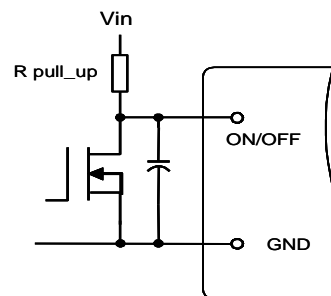


Figure 11. Circuit for Negative Logic Control

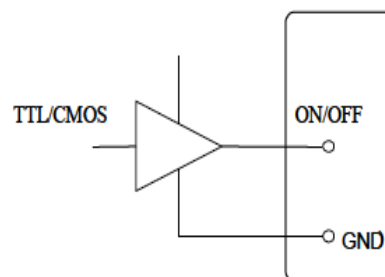


Figure 12. Direct Logic Drive

Output Voltage Adjustment (Trim)

This series of converters are available with both variable output and fixed output voltages. The variable output voltage model's output voltage is preset to 0.8V, and can be trimmed up to 5.5V using an external trim resistor. With a trim resistor, the output voltage of fixed output models can only be adjusted higher than the nominal output voltage. To trim the voltage lower than the nominal voltage, an external voltage higher than the nominal voltage has to be applied to the Trim pin.

The trim pin allows the user to adjust the output voltage set point with an external resistor or voltage. To increase the output voltage, a resistor should be connected between the TRIM pin and the GND pin. The output voltage can be adjusted down by changing the value of the external resistor using the equation below:

$$R_{trim} = \left(\frac{10.5}{\Delta} - 1 \right) (k\Omega)$$

Where

$$\Delta = V_o - V_{onom}$$

For variable output models, $V_{onom}=0.8$

The circuit configuration for trim operation is shown in Figure 13. Because NCT converters use GND as the reference for control, Rtrim should be placed as close to GND pin as possible, and the trace connecting GND pin and Rtrim should not carry significant current, to reduce the effect of voltage drop on the GND trace/plain on the output voltage accuracy. If negative remote sense pin option (Sense- selected in Option 2) is selected, the Sense- pin, instead of GND pins, should be connected to Rtrim.

When remote sense and trim functions are used simultaneously, please do not allow the output voltage at the converter output terminals to be outside the operating range.

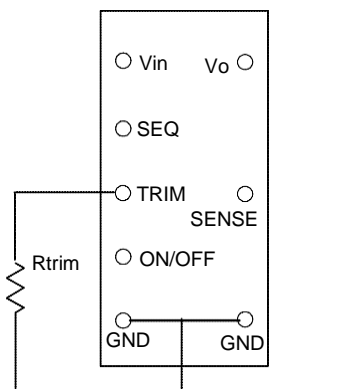


Figure 13. Circuit for Output Voltage Trim

Input Under-Voltage Lockout

This feature prevents the converter from starting until the input voltage reaches the turn-on voltage threshold, and keeps the converter running until the input voltage falls below the turn-off voltage threshold. The hysteresis prevents oscillations.

Output Over-Current Protection

As a standard feature, the converter turns off when the load current exceeds the current limit. If the over current or short circuit condition persists, the converter will operate in a hiccup mode (repeatedly trying to restart) until the over-current condition is cleared.

Thermal Shutdown

As a standard feature, the converter will shut down if an over-temperature condition is detected. The converter has a temperature sensor, which detects the thermal condition of key components of the converter.

The thermal shutdown circuit is designed to turn the converter off when the temperature at the sensor reaches 120°C. The converter will resume operation after the converter cools down.

Output Under-Voltage / Over-Voltage Protection

If the voltage sensed across the remote sense pins is 16% (typical) lower than the nominal output voltage, the converter will enter under-voltage protection and shut down (in hiccup mode). If the voltage sensed across the remote sense pins is 16% (typical) higher than the nominal output voltage, the converter will enter over voltage protection and shut down (in hiccup mode). The converter automatically resumes normal operation after the fault condition is removed.

Output Voltage Tracking / Sequencing

An optional voltage tracking/sequencing feature is available with these converters. This feature is compatible with the “Voltage Sequencing” feature (DOSA) or the “Voltage Tracking” feature (POLA) seen in industry standards.

This feature basically forces the output of the converter to follow the voltage at the SEQ pin until it reaches the set point during startup, or is completely shut down during turn off. The converter’s output voltage is controlled to be the same magnitude as the voltage on the SEQ pin, on a 1:1 basis. When using this function, one should pay careful attention to the following aspects:

- 1). This feature is intended mainly for startup and shutdown sequencing control. In normal operation,

the voltage at SEQ pin should be maintained higher than the output voltage set point.

2). The input voltage should be valid for this feature to work. During startup, it is recommended to have a delay of at least 10ms between the establishment of a valid input voltage, and the application of a voltage at the SEQ pin.

3). The ON/OFF pin should be in “Enabled” state when this function is effective.

4). The converter’s pre-bias startup is affected by this function. The converter will still be able to start under a pre-bias condition, but the output voltage waveform will have a glitch during startup if this feature is selected.

Frequency Synchronization

When multiple converters are used in a system, it is desirable to have all converters running at the same switching frequency to avoid the so-called “beat frequency” phenomenon and to reduce the system noise. The switching frequency of this series of POL converters can be synchronized to an outside clock. The clock frequency ratio is 8, which means the clock frequency should be set at 8 times the desired synchronized switching frequency. It’s desirable to limit the synchronized switching frequency within 10% range of the designed free-running switching frequency. For example, for converters with a nominal switching frequency of 270 kHz, the synchronized switching frequency should be in the range of 243 kHz to 297 kHz, which translates to a clock frequency between 1944 kHz to 2376 kHz.

The key parameters of the clock signal are: pulse duty ratio at 50% typically, logic HIGH level in 3.2–5.5V, logic LOW level less than 0.5V, and being able to source and sink at least 10 μ A current. The clock signal should be connected to the optional Pin 7 (“Option” pin). If Frequency Synchronization function is selected, the NCT module will NOT operate when there is NO frequency signal at Pin7.

The effective edge of the synchronization pulse is the falling edge of the clock signal.

Power Good

When POWER GOOD in Option 2 is selected (referring to the “Part numbering System” table), the option pin (pin 7) will serve as POWER GOOD signal pin to indicate the output status of the module. There is an open collector transistor with 10k pull up resistor connected to this POWER GOOD pin. The voltage for the pull up resistor is 5V internal bias. Before the output voltage of the NCT module reaches its regulation point, the open collector transistor will hold pin 7 to the ground. After the output voltage reaches the regulation point for 5ms, the open collector transistor will become high impedance and pin 7 will be pull to high.

Design Considerations

The stability of the NCT converters, as with any DC-DC converter, may be compromised if the source impedance is too high or too inductive. It’s desirable to keep the input source AC impedance as low as possible. To reduce switching frequency ripple current getting into the input circuit (especially the ground/return conductor), it is desirable to place some low ESR capacitors at the input. Due to the existence of some inductance (such as the trace inductance, connector inductance, etc) in the input circuit, possible oscillation may occur at the input of the converter. Because the relatively high input current of low input voltage power system, it may not be practical or economical to have separate damping or soft start circuit in front of POL converters. We recommend to use a combination of ceramic capacitors and Tantalum/Polymer capacitors at the input, so the relatively higher ESR of Tantalum/Polymer capacitors can help damp the possible oscillation between the ceramic capacitors and the inductance.

The converter is designed to be stable without additional output capacitors. To further reduce the output voltage ripple or improve the transient response, additional output capacitors are often used in applications. When additional output capacitors are used, a combination of ceramic capacitors and tantalum/polymer capacitors shall be used to provide good filtering while assuring the stability of the converter.

Safety Considerations

The NCT Series of converters is designed in accordance with EN 60950 Safety of Information Technology Equipment Including Electrical Equipment. The converters are recognized by UL in both USA and Canada to meet the requirements in UL 60950, Safety of Information Technology Equipment and applicable Canadian Safety Requirement, and ULc 60950. Flammability ratings of the PWB and plastic components in the converter meet 94V-0.

The converter's output meets SELV requirements if all of its input meets SELV requirements.

Thermal Considerations

The NCT converters can operate in various thermal environments. Due to high efficiency and optimal heat distribution, these converters exhibit excellent thermal performance.

The maximum allowable output power of any power converter is usually determined by the electrical design and the maximum operating temperature of its components. The NCT converters have been tested comprehensively under various conditions to generate the derating curves with consideration for long term reliability.

Thermal derating curves are highly influenced by derating guideline, the test conditions and setup, such as test temperatures, the interface method between the converter and the test fixture board, spacing and construction (especially copper weight, holes and openings) of the fixture board and the spacing board, temperature measurement method, and the ambient temperature measurement point. The thermal derating curves in this datasheet are obtained by thermal tests in a wind-tunnel. The converter's power pins are soldered to a 2-layer test fixture board through 18 AWG wires. The space between the test board and a PWB spacing board is 1". Usually, the end system board has more layer count, and has better thermal conductivity than our test fixture board.

Note that the natural convection condition was measured at 0.05 m/s to 0.15 m/s (10ft./min. to 30 ft./min).

Heat Transfer

Convection heat transfer is the primary cooling means for NCT converters. Therefore, airflow speed is important and increasing the airflow over the converter enhances the heat transfer via convection.

The current derating curves for a few output voltages are presented in this datasheet. To maintain long-term reliability, the module should be operated within these curves in steady state.

Proper cooling in the end system can be verified by monitoring the temperature of the key components. Figure 14 shows the recommended temperature monitoring points. The temperature at these locations should not exceed 125 °C continuously.

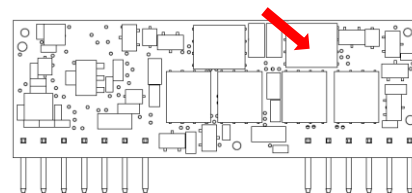
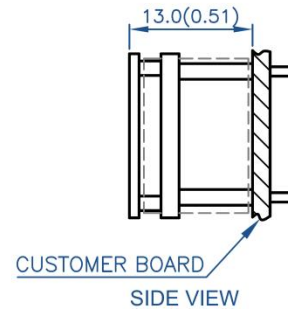
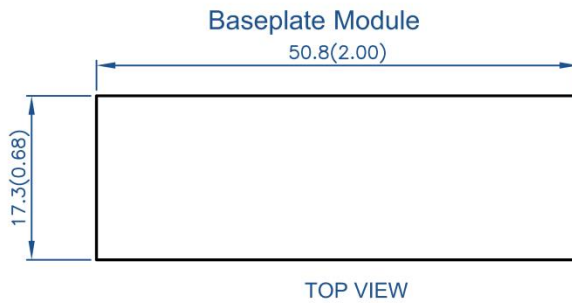
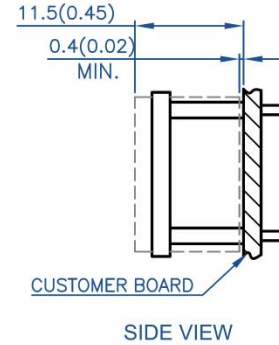
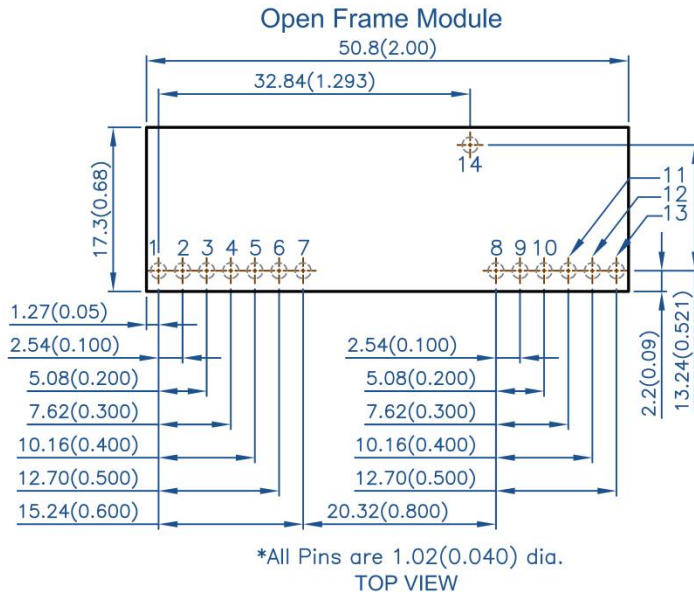


Figure 14. Temperature Monitoring Locations

Heat Transfer with a Baseplate

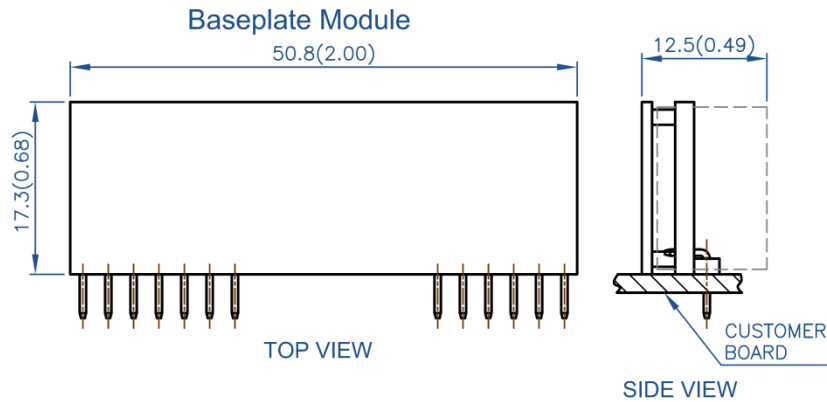
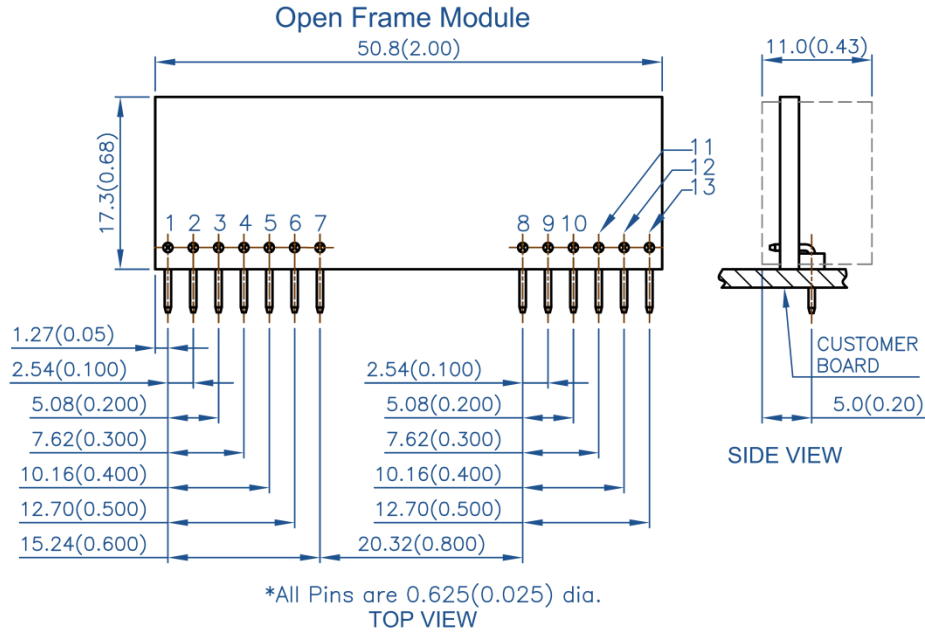
The NCT Series of converters have the options of using a baseplate for enhanced thermal performance. For reliable operation, the heat plate temperature should not continuously exceed 100 °C.

Mechanical Drawing
Horizontal Mount


Pin	Name	Function	Pin	Name	Function
1	Vout	Output voltage	8	GND	Power ground
2	Vout	Output voltage	9	Vin	Input voltage
3	SENSE(+)	Positive remote sense	10	Vin	Input voltage
4	Vout	Output voltage	11	SEQ	Tracking/Sequencing (optional)
5	GND	Power ground	12	TRIM	Output voltage adjustment
6	GND	Power ground	13	ON/OFF	Remote control
7	OPTION	Freq synch/Power good/SENSE-	14	NC	No connection

Notes:

- All dimensions in mm (inches)
Tolerances: .x ± .5 (.xx ± 0.02)
.xx ± .25 (.xxx ± 0.010)
- All pins are 1.02mm (0.040") dia. with +/- 0.10mm (0.004") tolerance. The recommended diameter of the receiving hole is 1.42mm (0.056").
- All pins are Copper Alloy, Matte Tin finish with Nickel under plating.
- Weight: 18.0g open frame converter
20.5g baseplate converter
- Workmanship: Meet or exceeds IPC-A-610 Class II
- Baseplate flatness tolerance is 0.10mm (0.004") TIR for surface.

Vertical Mount (SIP)


Pin	Name	Function	Pin	Name	Function
1	Vout	Output voltage	8	GND	Power ground
2	Vout	Output voltage	9	Vin	Input voltage
3	SENSE(+)	Positive remote sense	10	Vin	Input voltage
4	Vout	Output voltage	11	SEQ	Tracking/Sequencing (optional)
5	GND	Power ground	12	TRIM	Output voltage adjustment
6	GND	Power ground	13	ON/OFF	Remote control
7	OPTION	Freq synch/Power good/SENSE-			

Notes:

- 1) All dimensions in mm (inches)
Tolerances: .x ± .5 (.xx ± 0.02)
.xx ± .25 (.xxx ± 0.010)
- 2) All pins are 0.625mm (0.025") square.
- 3) All pins are Copper Alloy, Matte Tin finish with Nickel under plating.
- 4) Weight: 15.5g open frame converter
18.0g baseplate converter
- 5) Workmanship: Meet or exceeds IPC-A-610 Class II.
- 6) Baseplate flatness tolerance is 0.10mm (0.004") TIR for surface.