



## Features

- 4:1 wide input voltage range
- High efficiency up to 88.0%
- No-load power loss as low as 0.12W
- 3,000Vdc input to output isolation
- Input under-voltage, output over-current, over-voltage and short-circuit protections
- Operating temperature range: -40 to +85 °C
- Industry standard pin-out
- UL 60950-1 2nd edition recognized



## Part Numbering System

LM	x	x	xxx	P	6W	3	PP	C
Series Name	No. of Output	Input Range	Output Voltage	Enable Logic	Output Power	Isolation Voltage	Package	Version No.
	B: Dual S: Single	1: 9-36V 3: 18-75V	Example: 050: 5V	P: Positive	6W: 6W	3: 3000Vdc	PP: P package	C: Version No.

## Selection Guide

Part No.	Input Voltage (Vdc)	Output		Efficiency(%) at typical input & full load	Max. Load Capacitance (µF)
		Voltage(Vdc)	Current(mA)		
LMB1050P6W3PPC	24 (9-36)	±5	±600	80.0	680
LMB1120P6W3PPC		±12	±250	84.0	330
LMB1150P6W3PPC		±15	±200	85.0	220
LMS1033P6W3PPC		3.3	1500	79.0	2200
LMS1050P6W3PPC		5	1200	82.0	2200
LMS1090P6W3PPC		9	667	85.0	1000
LMS1120P6W3PPC		12	500	86.0	680
LMS1150P6W3PPC		15	400	88.0	680
LMS1240P6W3PPC		24	250	87.0	680
LMS3033P6W3PPC		48 (18-75)	3.3	1500	79.0
LMS3050P6W3PPC	5		1200	83.0	2200
LMS3120P6W3PPC	12		500	87.0	680
LMS3150P6W3PPC	15		400	88.0	680
LMS3240P6W3PPC	24		250	87.0	680

## Input Specifications

Parameter	Notes & Conditions	Min	Typical	Max	Unit	
Input Current(full load)	24Vdc input series	3.3V output	-	261	268	mA
		Others	-	297	320	
	48Vdc input series	3.3V output	-	131	134	
		Others	-	146	154	
Input Current (zero load)	24Vdc input series	3.3V output	-	10	16	
		Others	-	10	16	
	48Vdc input series	3.3V output	-	4	7	
		Others	-	4	7	
Reflected Ripple Current		-	20	-		
Surge Voltage (1sec. max.)	24Vdc input series	-0.7	-	50	Vdc	
	48Vdc input series	-0.7	-	100		
Starting Voltage	24Vdc input series	-	-	9		
	48Vdc input series	-	-	18		
Input Under-voltage protection	24Vdc input series	5.5	6.5	-		
	48Vdc input series	12	15.5	-		
Hot Plugging	Not supported					

## Output Specifications

Parameter	Notes & Conditions	Min	Typical	Max	Unit	
Output Voltage Accuracy	5%-100% of full load,	-	±1	±3	%Vo	
	0%-5% of full load	Single output	-	±1		±3
		Dual output	-	±2		±5
Balance of Output Voltage	Dual output, balanced load	-	±0.5	±1.5		
Line Regulation	Full range input voltage, full load	+Vout	-	±0.2		±0.5
		-Vout	-	±0.5		±1
Load Regulation	5%-100% of full load, nominal input	+Vout	-	±0.5		±1
		-Vout	-	±0.5		±1.5
Cross Regulation	Dual output, main circuit with 50% load, auxiliary circuit with 10%-100% of full load	-	-	±5		
Temperature Coefficient	Full load	-	-	0.03	%/°C	
Transient Recovery Time	25% load step, nominal input voltage	-	300	500	µs	
Transient Response Deviation		-	±3	±5	%Vo	
Ripple & Noise	20MHz bandwidth	-	85	120	mVp-p	
Ripple Frequency*		-	300	-	kHz	
Over-voltage Protection	Full input range	110	-	160	%Vo	
Over-current Protection	Full input range	24V output	110	220	290	%Io
		Others	110	140	190	
Short circuit Protection	Full input range	Hiccup mode, continuous, auto recovery				

\*The ripple frequency decreases as the load decreases at 50% or less of the full load.

## Safety and Environmental Specifications

Parameter	Notes & Conditions	Min	Typical	Max	Unit
Isolation Voltage	Input-Output, 1 minute, leakage current less than 1mA	3,000	-	-	Vdc
Insulation Resistance	Input-Output, isolation voltage 500Vdc	1,000	-	-	MΩ
Isolation Capacitance	Input-Output, 100KHz/0.1V	-	1,000	-	pF
Operating Temperature		-40	-	+85	°C
Storage Temperature		-55	-	+125	
Storage Humidity	Non-condensing	5	-	95	%RH
Vibration		10-55Hz, 2G, 30 min. along X, Y and Z			
MTBF	MIL-HDBK-217F@25°C	1	-	-	10 <sup>6</sup> hours

Note: Unless otherwise specified, data in this datasheet should be tested under the conditions of nominal input voltage, rated load and Ta=25°C.

## Other Specifications

Parameter	Notes
Case Material	Black flame-retardant heat-proof plastic (UL94-V0)
Dimensions	31.60 x 20.30 x 10.20 mm
Weight	13g (Typ.)
Cooling Method	Free air convection

## EMC Specifications

Parameter	Notes & Conditions		
EMI	CE	CISPR32/EN55032 CLASS A (Without extra components) / CLASS B (See Figure 6-②)	
	RE	CISPR32/EN55032 CLASS A (Without extra components) / CLASS B (See Figure 6-②)	
EMS	ESD	IEC/EN61000-4-2 Contact ±4KV	perf. Criteria B
	RS	IEC/EN61000-4-3 10V/m	perf. Criteria A
	EFT	IEC/EN61000-4-4 ±2KV (See Figure 6-①)	perf. Criteria B
	Surge	IEC/EN61000-4-5 ±2KV (See Figure 6-①)	perf. Criteria B
	CS	IEC/EN61000-4-6 3Vrms	perf. Criteria A
	Immunities of voltage dip, drop	IEC/EN61000-4-29 0%, 70%	perf. Criteria B

### Characteristic Curves

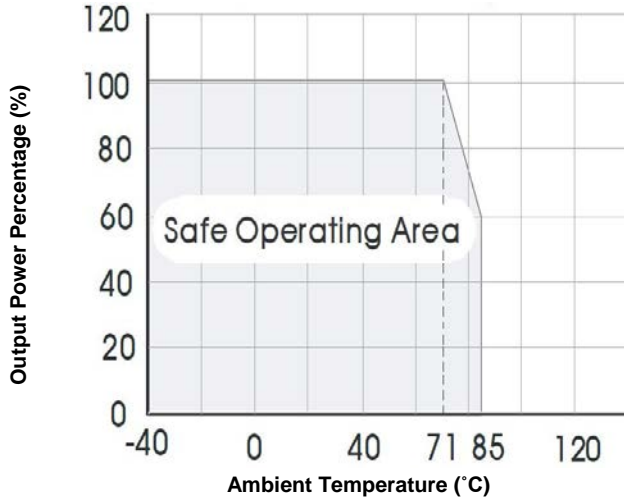

Figure 1. Temperature Derating Curve

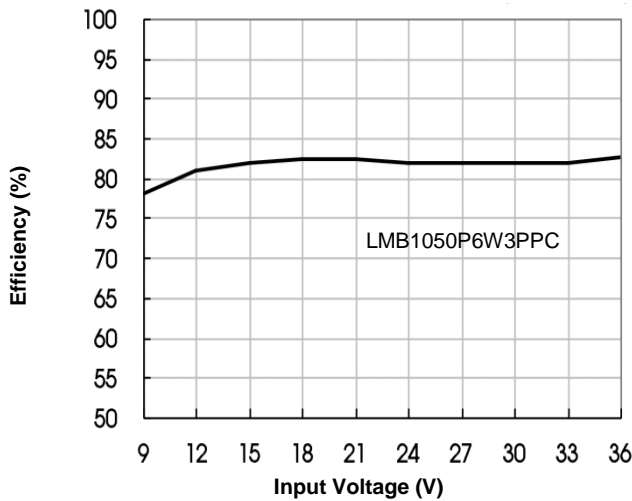

Figure 2. Efficiency vs. Input Voltage (full load)

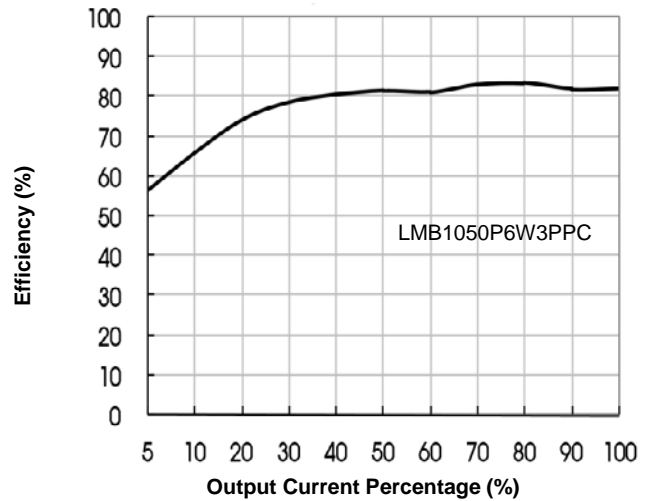

Figure 3. Efficiency vs. Output Load (Vin=24V)

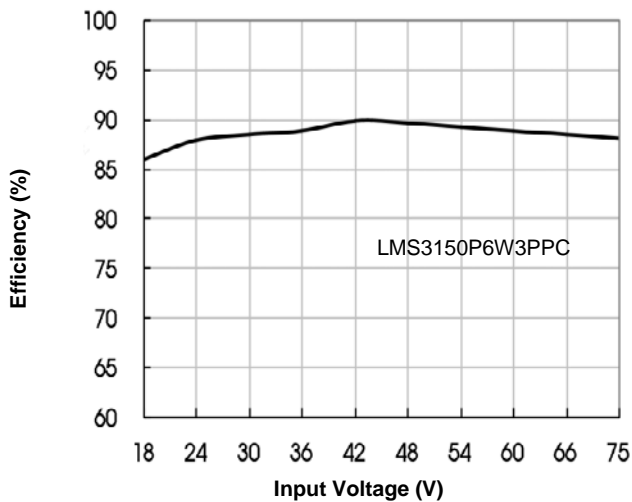

Figure 4. Efficiency vs. Input Voltage (full load)

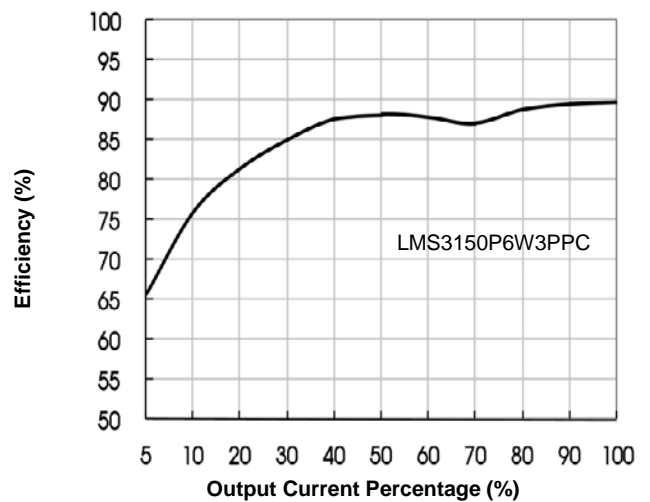
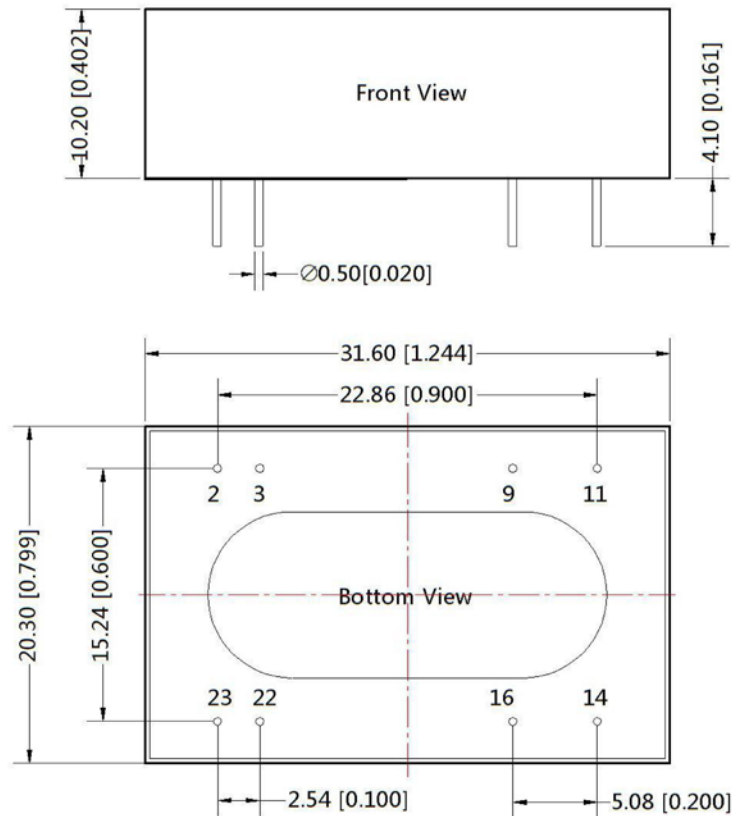

Figure 5. Efficiency vs. Output Load (Vin=48V)

## Mechanical Drawing



Single output		
Pin	Name	Function
2,3	Vin(-)	Negative input voltage
9	Omit	No pin
11	NC	No connection
14	Vout(+)	Positive output voltage
16	Vout(-)	Negative output voltage
22,23	Vin(+)	Positive input voltage
Dual output		
Pin	Name	Function
2,3	Vin(-)	Negative input voltage
9	COM	Output common GND
11	-Vout	Negative output voltage
14	+Vout	Positive output voltage
16	COM	Output common GND
22,23	Vin(+)	Positive input voltage

### Notes:

- 1) All dimension in mm(inches)  
Tolerances:  $\pm 0.50(\pm 0.020)$
- 2) Pin section tolerances :  $\pm 0.10(\pm 0.004)$

### EMC Typical Application Circuit

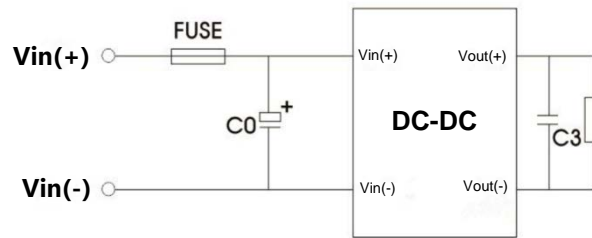

Figure 6-①. EMC Recommended Circuit

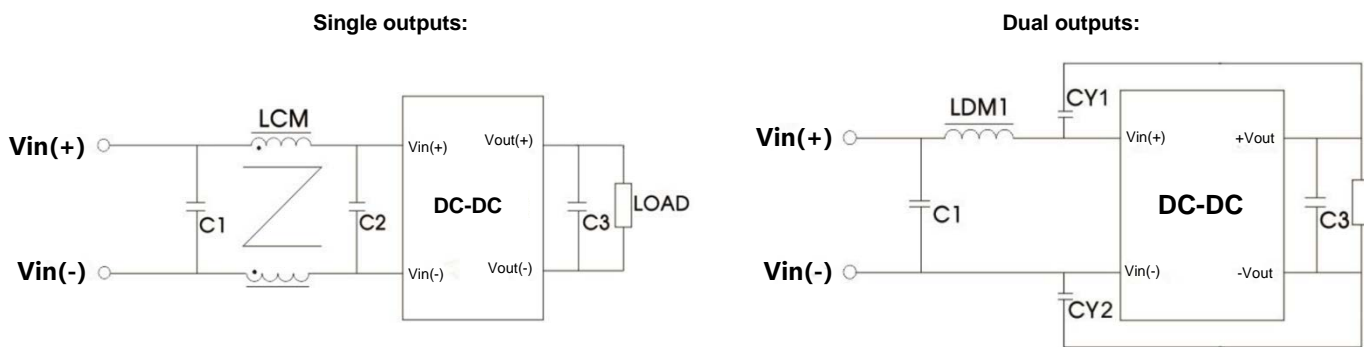

Figure 6-②. EMC Recommended Circuit

Component	Recommended Value (Dual outputs)		Component	Recommended Value (Single outputs)	
	24Vin			24Vin	48Vin
FUSE	Choose according to the actual input current		FUSE	Choose according to the actual input current	
C0	1000 $\mu$ F/50V		C0	1000 $\mu$ F/50V	680 $\mu$ F/100V
C1	1 $\mu$ F/50V		C1, C2	2.2 $\mu$ F/50V	2.2 $\mu$ F/100V
C3	10 $\mu$ F		LCM	2.2mH	
LDM1	4.7 $\mu$ H		C3	10 $\mu$ F	
CY1, CY2	1nF/3KV				