

Features

- High efficiency and excellent thermal performance
- Output remote sense
- Input under-voltage, output over-voltage, over-current, short-circuit and over-temperature protections
- Active current share
- Basic insulation, 2,250Vdc input to output isolation
- UL 62368-1 2nd edition recognized
- Qualification/Screening satisfy IPC-9592
- Wide operating temperature range from -40°C to +100°C



Part Numbering System

HYP	S3	□□□	□	□□□	□	□	□	□	-	□
Series Name	Input Voltage	Output Voltage	Enabling Logic	Rated Output Current	Pin Length	Options 1*	Options 2	Suffix	-	Operating Temperature Grade (°C)**
	See suffix	Example: 120: 12V	P: Positive N: Negative	Example: 030: 30A	K: 0.095" N: 0.130" R: 0.165"	0: I-share & latch off 2: I-share & auto-restart 5: No I-share & latch off 7: No I-share & auto-restart	P: Standard	W: 18-75V input range		C: -20 to +100 H: -40 to +100

* When "5" or "7" is selected, the "Share" pin (Pin S) does not exist.

** Operating temperature is the temperature measured at the center of the baseplate.

Available Codes:

Output Voltage	5V	12V	18V
Output Current	50A	30A	6A

Absolute Maximum Rating

Excessive stresses over these absolute maximum ratings can cause permanent damage to the converter. Operation should be limited to the conditions outlined under the Electrical Specification section.

Parameter	Min	Max	Unit
Input Voltage (continuous operating)	-0.5	75	V
Input Voltage (continuous, non-operating)	-	100	V
Input Voltage (<100ms, operating)	-	100	V
Storage Temperature	-55	125	°C

Electrical Specifications

These specifications are valid over the converter's full range of input voltage, resistive load, and temperature unless noted otherwise.

Input Specifications

Parameter	Min	Typical	Max	Unit
Input Voltage	18	36	75	V
Input Turn-on Voltage Threshold	16.0	17.0	17.5	V
Input Turn-off Voltage Threshold	15.0	15.5	16.0	V

For 5V/50A output module, the (Min, Typical, Max) value of "Input Turn-on Voltage Threshold" is (16, 17, 18) V, and the (Min, Typical, Max) value of "Input Turn-off Voltage Threshold" is (9, 10, 11) V.

For 18V/6A output module, the (Min, Typical, Max) value of "Input Turn-on Voltage Threshold" is (17.0, 17.5, 18.0) V, and the (Min, Typical, Max) value of "Input Turn-off Voltage Threshold" is (16.0, 16.5, 17.0) V.

Output Specifications

Parameter	Min	Typical	Max	Unit
Output Voltage Set Point Accuracy (typical Vin, full load, Ta = 25°C)	-1.5	-	+1.5	%Vo
Output Voltage Set Point Accuracy (over all conditions)	-3.0	-	+3.0	%Vo
Output Regulation:				
Line Regulation (full range input voltage, 1/2 full load)	-	0.2	0.5	%Vo
Load Regulation (full range load, typical Vin)	-	0.2	0.5	%Vo
Temperature (Ta = -40°C to 85 °C)	-	0.1	-	%Vo
Output Trim Range in % of typical Vo ¹	80	-	110	%

General Specifications

Parameter	Min	Typical	Max	Unit
Remote Enable				
Logic Low:				
ION/OFF = 1.0mA	0	-	1.2	V
VON/OFF = 0.0V	-	-	1.0	mA
Logic High:				
ION/OFF = 0.0μA	3.5	-	15	V
Leakage Current	-	-	50	μA
Isolation Capacitance	-	4,700	-	pF
Insulation Resistance	10	-	-	MΩ

¹ For 18V/6A output module, the trim range is 95%-110%.

Module Specific Specifications

5V/50A Module (HYP3050x050xxxW-x)

Parameter	Min	Typical	Max	Unit
Input Current	-	-	33	A
Quiescent Input Current (typical Vin)	-	310	350	mA
Standby Input Current	-	24	30	mA
Efficiency (typical Vin, full load, Ta = 25°C)	-	90.0	-	%
Output Voltage Set Point	-	5.0	-	V
Output Power	0	-	250	W
Output Over Current Protection Set Point	110	160	180	%
Output Over Voltage Protection Set Point	115	130	160	%
Output Ripple Frequency	220	250	280	kHz
Output Ripple and Noise Voltage RMS	-	9	15	mVrms
Peak-to-peak (5Hz to 20MHz bandwidth, typical Vin)	-	40	80	mVp-p
External Load Capacitance	-	-	4,000	µF

12V/30A Module (HYP3120x030xxxW-x)

Parameter	Min	Typical	Max	Unit
Input Current	-	-	28	A
Quiescent Input Current (typical Vin)	-	200	250	mA
Standby Input Current	-	8	20	mA
Efficiency (typical Vin, full load, Ta = 25°C)	-	90.5	-	%
Output Voltage Set Point	-	12.0	-	V
Output Power	0	-	360	W
Output Over Current Protection Set Point	103	-	140	%
Output Over Voltage Protection Set Point	115	125	135	%
Output Ripple Frequency	220	250	280	kHz
Output Ripple and Noise Voltage RMS	-	30	60	mVrms
Peak-to-peak (5Hz to 20MHz bandwidth, typical Vin)	-	120	200	mVp-p
External Load Capacitance	-	-	4,700	µF

18V/6A Module (HYP3180x006xxxW-x)

Parameter	Min	Typical	Max	Unit
Input Current	-	-	10	A
Quiescent Input Current (typical Vin)	-	100	140	mA
Standby Input Current	-	20	25	mA
Efficiency (typical Vin, full load, Ta = 25°C)	-	91.0	-	%
Output Voltage Set Point	-	18.0	-	V
Output Power	0	-	108	W
Output Over Current Protection Set Point	120	160	175	%
Output Over Voltage Protection Set Point	120	135	150	%
Output Ripple Frequency	230	250	270	kHz
Output Ripple and Noise Voltage RMS	-	3	5	mVrms
Peak-to-peak (5Hz to 20MHz bandwidth, typical Vin)	-	25	50	mVp-p
External Load Capacitance	-	-	4,000	µF

Feature Descriptions

Remote ON/OFF

The converter can be turned on and off by changing the voltage between the ON/OFF pin and Vin(-). The HYPS3 Series of converters is available with factory selectable positive logic and negative logic.

For the negative control logic, the converter is ON when the ON/OFF pin is at a logic low level and OFF when the ON/OFF pin is at a logic high level. For the positive control logic, the converter is ON when the ON/OFF pin is at a logic high level and OFF when the ON/OFF pin is at a logic low level.

With the internal pull-up circuitry, a simple external switch between the ON/OFF pin and Vin(-) can control the converter. A few example circuits for controlling the ON/OFF pin are shown in Figures 1, 2 and 3.

The logic low level is from 0V to 1.2V and the maximum sink current during logic low is 1mA. The external switch must be capable of maintaining a logic-low level while sinking up to this current. The logic high level is from 3.5V to 15V. The converter has an internal pull-up circuit that ensures the ON/OFF pin at a high logic level when the leakage current at ON/OFF pin is no greater than 50µA.

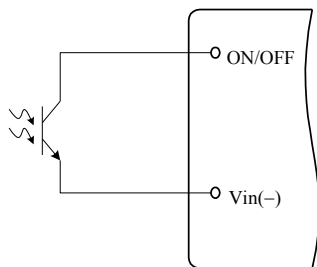

Figure 1. Opto Coupler Enable Circuit

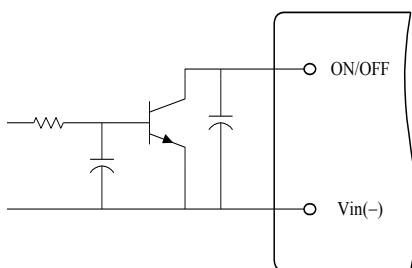

Figure 2. Open Collector Enable Circuit

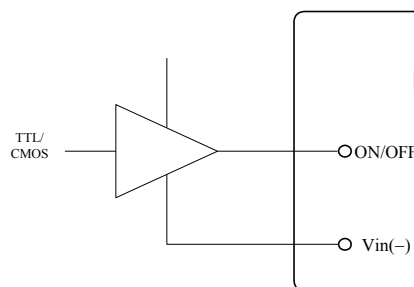

Figure 3. Direct Logic Drive

Remote SENSE

The remote SENSE pins are used to sense the voltage at the load point to accurately regulate the load voltage and eliminate the impact of the voltage drop in the power distribution path.

SENSE (+) and SENSE (-) pins should be connected between the points where voltage regulation is desired. The voltage between the SENSE pins and the output pins must not exceed the smaller of 0.5V or 10% of typical output voltage.

$$[V_{out (+)} - V_{out (-)}] - [SENSE (+) - SENSE (-)] < \text{MIN} \{0.5V, 10\%V_o\}$$

When remote sense is not used, the SENSE pins should be connected to their corresponding output pins. If the SENSE pins are left floating, the converter will deliver an output voltage slightly higher than its specified typical output voltage.

Output Voltage Adjustment (Trim)

The trim pin allows the user to adjust the output voltage set point. To increase the output voltage, an external resistor is connected between the TRIM pin and SENSE(+). To decrease the output voltage, an external resistor is connected between the TRIM pin and SENSE(-). The output voltage trim range is 80% to 110% of the specified typical output voltage.

The circuit configuration for trim down operation is shown in Figure 4. To decrease the output voltage, the value of the external resistor should be

$$R_{down} = \left(\frac{100}{\Delta} - 2 \right) (k\Omega)$$

Where

$$\Delta = \left(\frac{|V_{nom} - V_{adj}|}{V_{nom}} \right) \times 100$$

And

V_{nom} = Typical Output Voltage
 V_{adj} = Adjusted Output Voltage

The circuit configuration for trim up operation is shown in Figure 5. To increase the output voltage, the value of the resistor should be

$$R_{up} = \left(\frac{V_o(100 + \Delta)}{1.225\Delta} - \frac{100}{\Delta} - 2 \right) (k\Omega)$$

Where

V_o = Typical Output Voltage

As the output voltage at the converter output terminals are higher than the specified typical level when using the trim up and/or remote sense functions, it is important to make sure that the voltage at the output terminals does not exceed the maximum power rating of the converter as given in the specifications table.

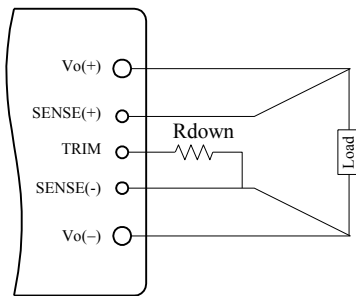

Figure 4. Circuit to Decrease Output Voltage

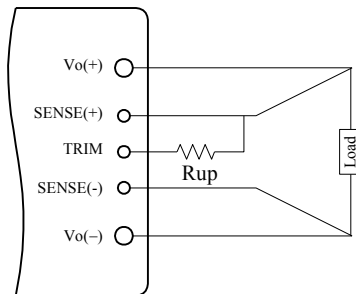

Figure 5. Circuit to Increase Output Voltage

Active Current Sharing (Parallel)

Share pin is designed for active current share among modules in parallel.

The active current share feature allows multiple converters to share load current. For the parallel operation of multiple converters, the Share pins of the converter should be connected together. It is suggested to have a ground plane on the system board for $V_{in}(-)$ to reduce the ground noise impact on the current sharing accuracy. The loop formed by the trace connecting the Share pins and the ground trace should be minimized to avoid noise coupling into the current share circuitry.

The HYP3 converter with current share feature has an internal oring FET at its output. The output pins of the current sharing converters can be directly connected together. A typical current share schemes for the HYP3 Series of converters is shown in Figure 6.

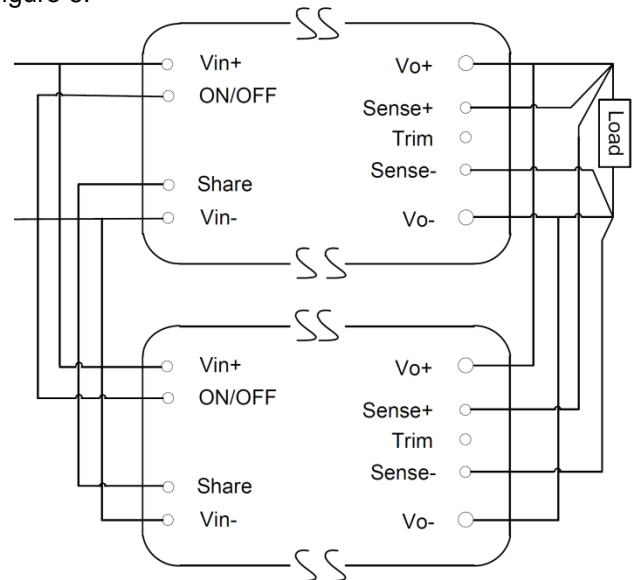

Figure 6. Circuit Configuration for Active Current Sharing

If parallel feature is not needed, just let share pin open.

Input Under-Voltage Lockout

This feature prevents the converter from starting until the input voltage reaches the turn-on voltage threshold, and keeps the converter running until the input voltage falls below the turn-off voltage threshold. Both turn-on and turn-off voltage thresholds are defined in the Input Specifications table.

Output Over-Current Protection (OCP)

This converter can be ordered in either latch-off or auto-restart version upon OCP, OVP, and OTP.

With the latch-off version, the converter will latch off when the load current exceeds the limit. The converter can be restarted by toggling the ON/OFF switch or recycling the input voltage.

With the auto-restart version, the converter will operate in a hiccup mode (repeatedly try to restart) until the cause of the over-current condition is cleared.

Output Over-Voltage Protection (OVP)

With the latch-off version, the converter will latch off when the output voltage exceeds the limit. The converter can be restarted by toggling the ON/OFF switch or recycling the input voltage.

With the auto-restart version, the converter will operate in a hiccup mode (repeatedly try to restart) until the cause of the over-voltage condition is cleared.

Over Temperature Protection (OTP)

With the latch-off version, the converter will shut down and latch off if an over-temperature condition is detected. The converter has a temperature sensor located at a carefully selected position, which represents the thermal condition of key components of the converter. The thermal shutdown circuit is designed to turn the converter off when the temperature at the sensor reaches 120°C. The module can be restarted by toggling the ON/OFF switch or recycling the input voltage.

With the auto-restart version, the converter will resume operation after the converter cools down.

Design Considerations

As with any DC-DC converter, the stability of the HYP3 converter may be compromised if the source impedance is too high or inductive. It's desirable to keep the input source ac-impedance as low as possible. Although the converters are designed to be stable without adding external input capacitors for typical source impedance, it is recommended to add 100 μ F low ESR electrolytic capacitors at the input of the converter for each 100W output power, which reduces the potential negative impact of the source impedance on the converter stability. These electrolytic capacitors should have sufficient RMS current rating over the operating temperature range.

The converter is designed to be stable without additional output capacitors. To further reduce the output voltage ripple or improve the transient response, additional output capacitors are often used in applications. When additional output capacitors are used, a combination of ceramic capacitors and tantalum/polymer capacitors shall be used to provide good filtering while assuring the stability of the converter.

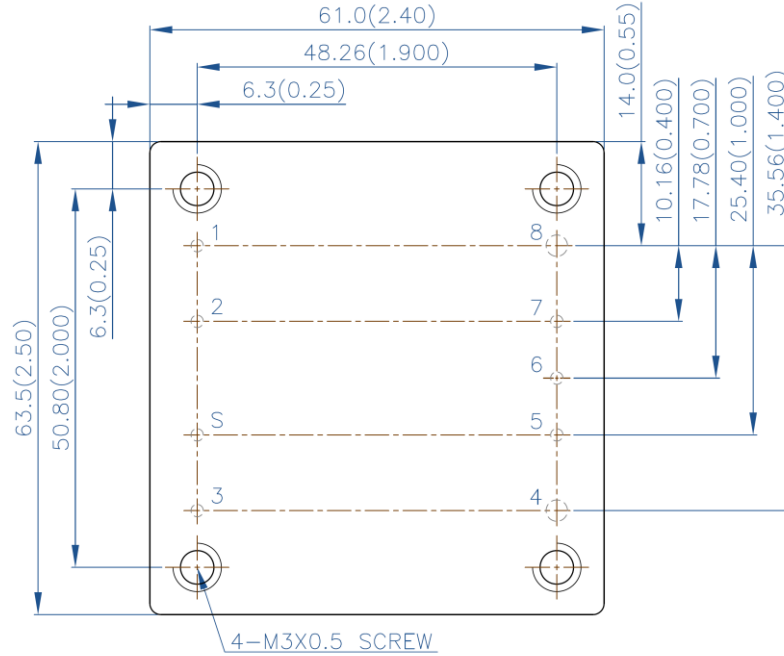
Mechanical Drawing

*Pin 1,2,S,3,5,6,7 are 1.02(0.040) dia.
 *Pin 4,8 are 2.03(0.080) dia.

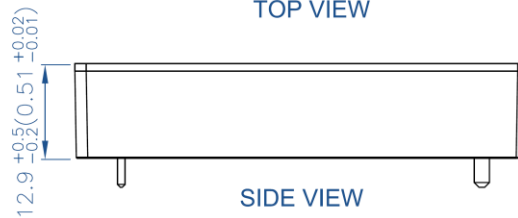
TOP VIEW

SIDE VIEW

Pin	Name	Function
1	Vin(+)	Positive input voltage
2	ON/OFF	Remote control
S	SHARE	Current share (optional)
3	Vin(-)	Negative input voltage
4	Vout(-)	Negative output voltage
5	SENSE(-)	Negative remote sense
6	TRIM	Output voltage adjustment
7	SENSE(+)	Positive remote sense
8	Vout(+)	Positive output voltage

Notes:

- All dimensions in mm (inches)
 Tolerances: .x ± .5 (.xx ± 0.02)
 .xx ± .25 (.xxx ± 0.010)
- Input and function pins are 1.02mm (0.040") dia. with +/- 0.10mm (0.004") tolerance. The recommended diameter of the receiving hole is 1.42mm (0.056").
- Output pins are 2.03mm (0.080") dia. with +/- 0.10mm (0.004") tolerance. The recommended diameter of the receiving hole is 2.44mm (0.096").
- All pins are Copper Alloy, Matte Tin finish with Nickel under plating.
- Typical weight: 145g.
- Workmanship meets or exceeds IPC-A-610 Class II.
- Torque applied on screw should not exceed 6in-lb. (0.7 Nm).
- Baseplate flatness tolerance is 0.10mm (0.004") TIR for surface.