

15V 20A Half Brick Converter



Features

- High Efficiency: 91.5% (15V/20A)
- Excellent thermal performance
- Output remote sense
- Output over-voltage, over-current, short-circuit, and over-temperature protections
- Current share
- Fixed frequency operation
- Basic Insulation, 2,250Vdc input to output isolation
- UL 62368-1 2nd edition recognized[†]



Options

- Baseplate
- Auto-restart / Latch off after fault shutdown
- Negative / Positive enable logic
- Active current share (Parallel)
- Pin lengths

Part Numbering System

HPS	1	150	□	020	□	□	□
Series Name	Input Voltage	Output Voltage	Enabling Logic	Rated Output Current	Pin Length Options	Electrical Options*	Mechanical Options Lead-free (ROHS-6 Compliant)
	1: 9-36V	Unit: 0.1V 150: 15V	P: Positive N: Negative	Unit: A 020: 20A	K: 0.110" N: 0.145" R: 0.180"	0: I-share & latch off 2: I-share & auto-restart 5: No I-share & latch off 7: No I-share & auto-restart	5: Open-frame 6: Baseplate

* When "5" or "7" is selected, the "Share" pin (Pin S) does not exist.

[†]UL is a registered trademark of Underwriters Laboratory Inc.

Absolute Maximum Rating

Excessive stresses over these absolute maximum ratings can cause permanent damage to the converter. Operation should be limited to the conditions outlined under the Electrical Specification Section.

Parameter	Min	Max	Unit
Input Voltage (continuous)	-0.5	40	Vdc
Input Voltage (< 100ms, operating)	-	50	Vdc
Input Voltage (continuous, non-operating)	-	50	Vdc
Operating Ambient Temperature (See Thermal Considerations section)	-40	85*	°C
Storage Temperature	-55	125	°C

*Derating curves provided in this datasheet end at 85°C ambient temperature. Operation above 85°C ambient temperature is allowed provided the temperatures of the key components or the baseplate do not exceed the limit stated in the Thermal Considerations section.

Electrical Specifications

These specifications are valid over the converter's full range of input voltage, resistive load, and temperature unless noted otherwise.

Input Specifications

Parameter	Min	Typical	Max	Unit
Input Voltage	9	18	36	Vdc
Input Current	-	-	50	A
Quiescent Input Current (typical Vin)	-	500	550	mA
Standby Input Current	-	15	20	mA
Input Turn-on Voltage Threshold	8	8.5	9	V
Input Turn-off Voltage Threshold	6	6.5	7.5	V
Input Voltage ON/OFF Hysteresis	-	1	-	V

Output Specifications

Parameter	Min	Typical	Max	Unit
Output Voltage Set Point (typical Vin; full load; Ta = 25°C)	-	15.0	-	V
Output Voltage Set Point Accuracy (typical Vin; full load; Ta = 25°C)	-1.5	-	+1.5	%Vo
Output Voltage Set Point Accuracy (over all conditions)	-3	-	+3	%Vo
Output Regulation:				
Line Regulation (full range input voltage, 1/2 full load)	-	0.2	0.5	%Vo
Load Regulation (full range load, typical Vin)	-	0.2	0.5	%Vo
Temperature (Ta = -40°C to 85 °C)	-	0.1	-	%Vo
Output Ripple and Noise Voltage				
RMS	-	8	15	mVrms
Peak-to-peak (5 Hz to 20 MHz bandwidth, typical Vin)	-	50	80	mVp-p
Output Current	0	-	20	A
Output Power	0	-	300	W

Output Specifications (Continued)

Parameter	Min	Typical	Max	Unit
Efficiency (typical V_{in} ; full load; $T_a = 25^\circ\text{C}$)	-	91.5	-	%
Output Ripple Frequency	260	280	300	kHz
External Load Capacitance	-	-	4,000	μF
Startup Delay, duration from enabling signal to V_o reaches 10% of its set point. (typical V_{in} ; full load; $T_a = 25^\circ\text{C}$)	-	45	-	ms
Startup Time, duration for V_o to rise from 10% of its set point to within its regulation band. (typical V_{in} ; full load; $T_a = 25^\circ\text{C}$)	-	50	-	ms
Output Over Current Protection Set Point (full load)	110	130	175	%
Output Over Voltage Protection Set Point (typical V_o)	110	130	150	%
Output Trim Range in % of typical V_o	80	-	110	%
Dynamic Response (typical V_{in} ; $T_a = 25^\circ\text{C}$; load transient $0.1\text{A}/\mu\text{s}$) Load steps from 50% to 75% of full load: Peak deviation Settling time (within 10% band of V_o deviation) Load step from 75% to 50% of full load: Peak deviation Settling time (within 10% band of V_o deviation)		5 300		% V_o μs
		5 300		% V_o μs

General Specifications

Parameter	Min	Typical	Max	Unit
Remote Enable Logic Low: ION/OFF = 1.0mA VON/OFF = 0.0V	0 -	- -	1.2 1.0	V mA
Logic High: ION/OFF = 0.0 μA Leakage Current	3.5 -	- -	15 50	V μA
Isolation Capacitance	-	4,700	-	pF
Insulation Resistance	10	-	-	M Ω
Calculated MTBF (Telecordia SR-332, 2011, Issue 3), full load, 40°C , 60% upper confidence level, typical V_{in}	-	6.8	-	10^6 -hour

Characteristic Curves

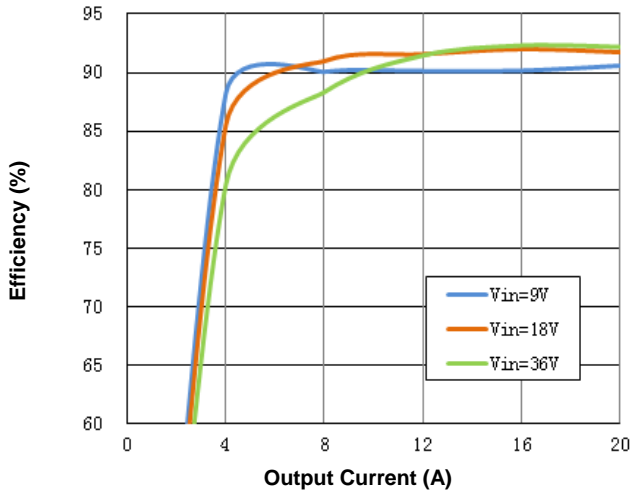

Figure 1. Efficiency vs. Load Current (25°C)

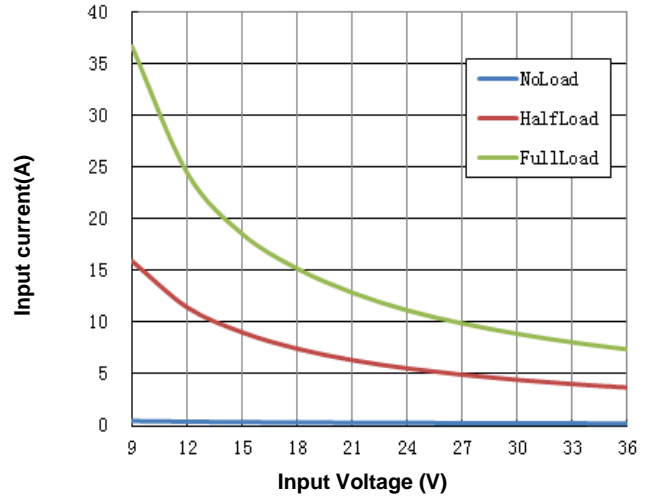

Figure 2. Input Characteristic (25°C)

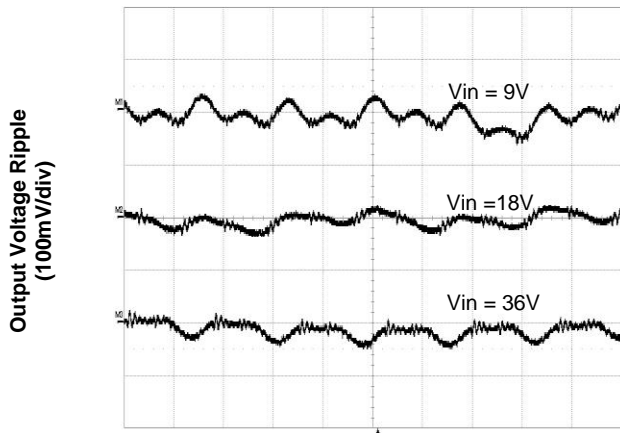

Figure 3. Output Ripple Voltage at Full Load

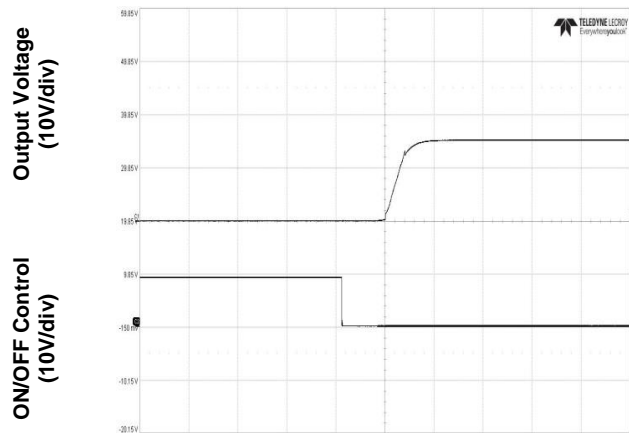

Figure 4. Start-Up from Enable Control (typical Vin, full load)

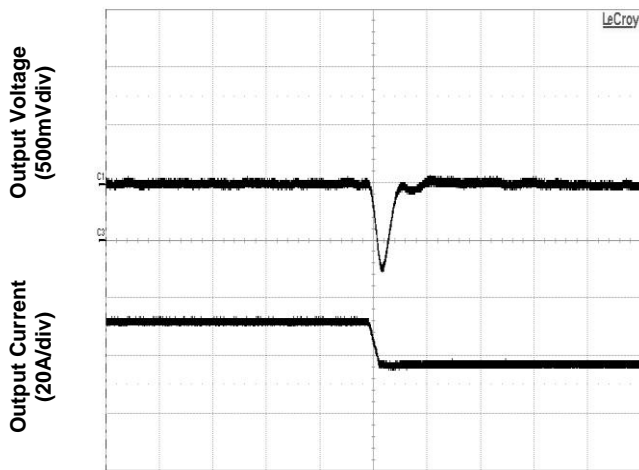

Figure 5. Transient Load Response (typical Vin, load current steps from 75% to 50% at a slew rate 0.1A/µs)

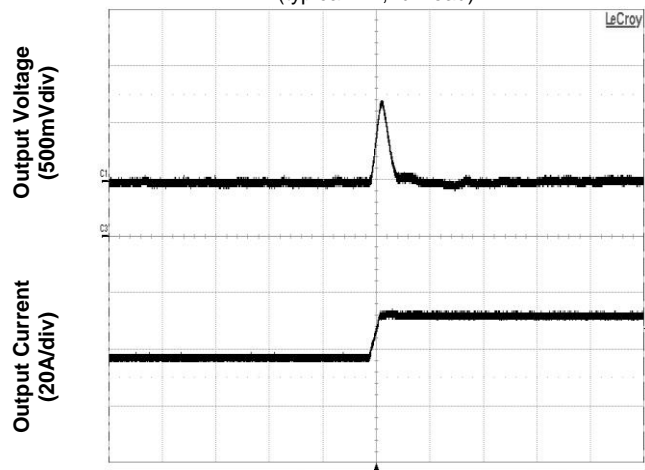

Figure 6. Transient Load Response (typical Vin, load current steps from 50% to 75% at a slew rate 0.1A/µs)

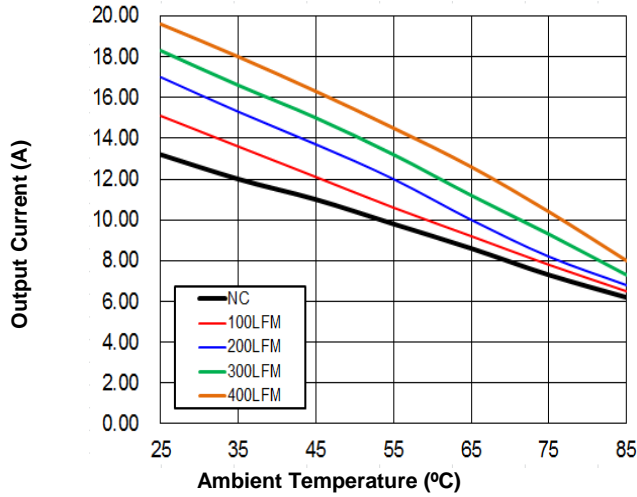

Figure 7. Current Derating Curve with Open Frame (Direction 3 (Ref. Figure 8); typical Vin, unit soldered onto a fixture board)

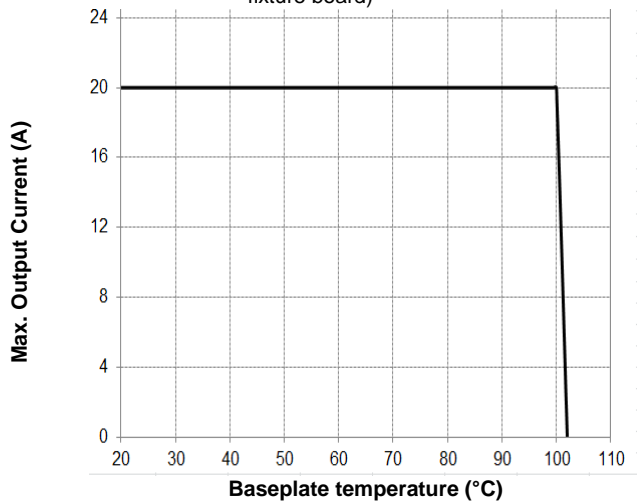

Figure 9. Current Derating Curve for Baseplate (typical Vin with baseplate; solder interface)

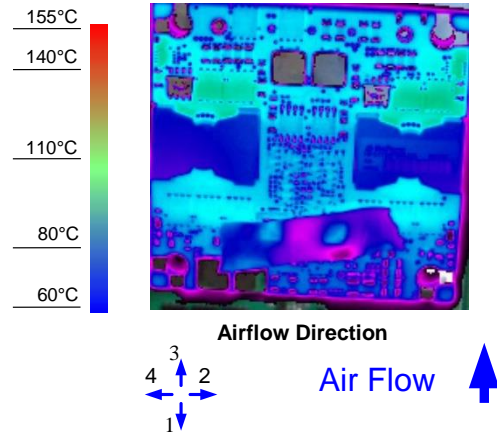

Figure 8. Thermal Image for Airflow Direction 3 (12A output, 55°C ambient, 200 LFM, typical Vin, open frame unit)

Feature Descriptions

Remote ON/OFF

The converter can be turned on and off by changing the voltage between the ON/OFF pin and Vin(-). The HPS1 Series of converters is available with factory selectable positive logic and negative logic.

For the negative control logic, the converter is ON when the ON/OFF pin is at a logic low level and OFF when the ON/OFF pin is at a logic high level. For the positive control logic, the converter is ON when the ON/OFF pin is at a logic high level and OFF when the ON/OFF pin is at a logic low level.

With the internal pull-up circuitry, a simple external switch between the ON/OFF pin and Vin(-) can control the converter. A few example circuits for controlling the ON/OFF pin are shown in Figures 10, 11 and 12.

The logic low level is from 0V to 1.2V and the maximum switch current during logic low is 1mA. The external switch must be capable of maintaining a logic-low level while sinking up to this current. The maximum voltage at the ON/OFF pin generated by the converter internal circuitry is less than 15V. The maximum allowable leakage current is 50µA.

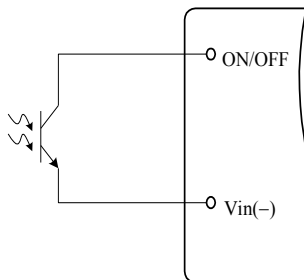

Figure 10. Opto Coupler Enable Circuit

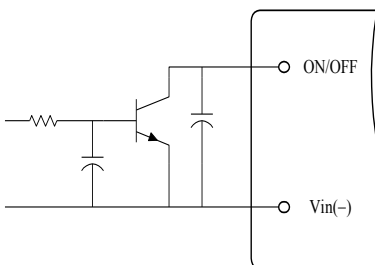

Figure 11. Open Collector Enable Circuit

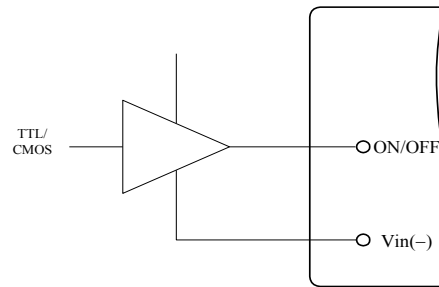

Figure 12. Direct Logic Drive

Remote SENSE

The remote SENSE pins are used to sense the voltage at the load point to accurately regulate the load voltage and eliminate the impact of the voltage drop in the power distribution path.

SENSE(+) and SENSE(-) pins should be connected to the point where regulation is desired. The voltage between the SENSE pins and the output pins must not exceed the smaller of 0.5V or 10% of typical output voltage.

$$[V_{out(+)} - V_{out(-)}] - [SENSE(+)-SENSE(-)] < \text{MIN} \{0.5V, 10\%V_o\}$$

When remote sense is not used, the SENSE pins should be connected to their corresponding output terminals (positive and negative). If the SENSE pins are left floating, the converter will deliver an output voltage slightly higher than its specified typical output voltage.

Output Voltage Adjustment (Trim)

The trim pin allows the user to adjust the output voltage set point. To increase the output voltage, an external resistor is connected between the TRIM pin and SENSE(+). To decrease the output voltage, an external resistor is connected between the TRIM pin and SENSE(-). The output voltage trim range is 80% to 110% of its specified nominal output voltage.

The circuit configuration for trim down operation is shown in Figure 13. To decrease the output voltage, the value of the external resistor should be

$$R_{down} = \left(\frac{100}{\Delta} - 2 \right) (k\Omega)$$

Where

$$\Delta = \left(\frac{|V_{nom} - V_{adj}|}{V_{nom}} \right) \times 100$$

And

V_{nom} = Nominal Output Voltage
 V_{adj} = Adjusted Output Voltage

The circuit configuration for trim up operation is shown in Figure 14. To increase the output voltage, the value of the resistor should be

$$R_{up} = \left(\frac{V_o(100 + \Delta)}{1.225\Delta} - \frac{100}{\Delta} - 2 \right) (k\Omega)$$

Where

V_o = Nominal Output Voltage

As the output voltage at the converter output terminals are higher than the specified nominal level when using the trim up and/or remote sense functions, it is important not to exceed the maximum power rating of the converter as given in the Specifications table.

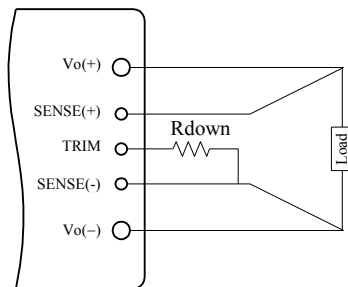

Figure 13. Circuit to Decrease Output Voltage

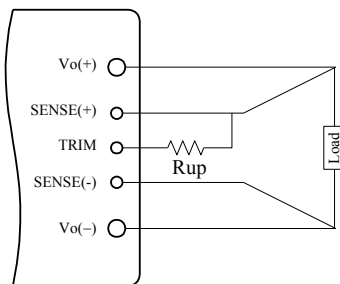

Figure 14. Circuit to Increase Output Voltage

Active Current Share (Parallel)

Share pin is designed for active current share among modules in parallel.

The active current share feature allows multiple converters to share load current. For the parallel operation of multiple converters, The Share pin on each converter should be connected together. It is suggested to have a ground plane on the system board for $V_{in}(-)$ to reduce the ground noise impact on the current share accuracy. The loop formed by the trace connecting the Share pins and the ground trace should be minimized to avoid noise coupling into the current share circuitry.

The HPS1 converter with current share feature has an internal oring FET at its output. The output pins of the current sharing converters can be directly connected together. A typical current share scheme for the HPS1 series of converters is shown in Figure 15.

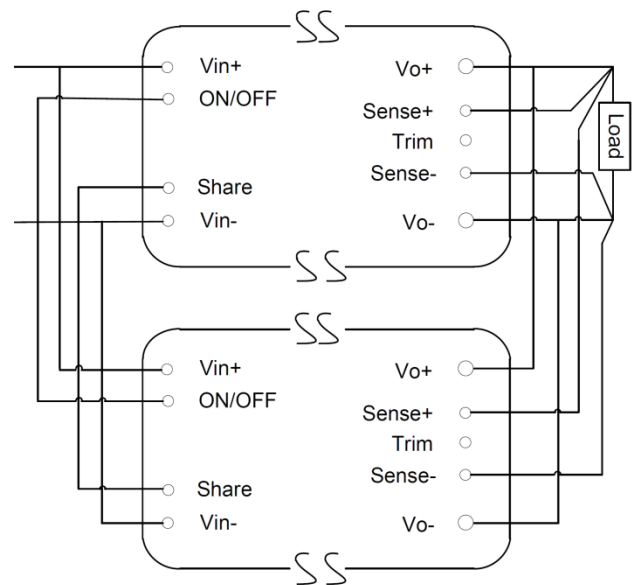

Figure 15. Circuit Configuration for Active Current Share

If parallel feature is not needed, just let share pin open.

Input Under-Voltage Lockout

This feature prevents the converter from starting until the input voltage reaches the turn-on voltage threshold, and keeps the converter running until the input voltage falls below the turn-off voltage threshold. Both turn-on and turn-off voltage thresholds are defined in the Input Specifications table. The hysteresis prevents oscillations.

Output Over-Current Protection (OCP)

This converter can be ordered in either latch-off or auto-restart version upon OCP, OVP, and OTP.

With the latch-off version, the converter will latch off when the load current exceeds the limit. The converter can be restarted by toggling the ON/OFF switch or recycling the input voltage.

With the auto-restart version, the converter will operate in a hiccup mode (repeatedly try to restart) until the cause of the over-current condition is cleared.

Output Over-Voltage Protection (OVP)

With the latch-off version, the converter will shut down when the output voltage exceeds the limit. The converter can be restarted by toggling the ON/OFF switch or recycling the input voltage.

With the auto-restart version, the converter will operate in a hiccup mode (repeatedly try to restart) until the cause of the over-voltage condition is cleared.

Over Temperature Protection (OTP)

With the latch-off version, the converter will shut down and latch off if an over-temperature condition is detected. The converter has a temperature sensor located at a carefully selected position in the converter circuit board, which represents the thermal condition of key components of the converter. The thermal shutdown circuit is designed to turn the converter off when the temperature at the sensor reaches 120°C. The module can be restarted by toggling the ON/OFF switch or recycling the input voltage.

With the auto-restart version, the converter will resume operation after the converter cools down.

Design Considerations

As with any DC/DC converter, the stability of the HPS1 converters may be compromised if the source impedance is too high or inductive. It's desirable to keep the input source ac-impedance as low as possible. Although the converters are designed to be stable without adding external input capacitors for

typical source impedance, it is recommended to add 220 μ F low ESR electrolytic capacitors at the input of the converter for each 100W output power, which reduces the potential negative impact of the source impedance on the converter stability. These electrolytic capacitors should have sufficient RMS current rating over the operating temperature range.

The converter is designed to be stable without additional output capacitors. To further reduce the output voltage ripple or improve the transient response, additional output capacitors are often used in applications. When additional output capacitors are used, a combination of ceramic capacitors and tantalum/polymer capacitors shall be used to provide good filtering while assuring the stability of the converter.

Safety Considerations

The HPS1 Series of converters are designed in accordance with EN 62368 Safety of Information Technology Equipment Including Electrical Equipment. The converters meet the requirements in UL 62368, Safety of Information Technology Equipment and applicable Canadian Safety Requirement, and ULc 62368. Flammability ratings of the PWB and plastic components in the converter meet 94V-0.

To protect the converter and the system, an input line fuse is highly recommended on the un-grounded input end.

Thermal Considerations

The HPS1 Series of converters can operate in various thermal environments. Due to the high efficiency and optimal heat distribution, these converters exhibit excellent thermal performance.

The maximum allowable output power of any power converter is usually determined by the electrical design and the maximum operating temperature of its components. The HPS1 Series of converters have been tested comprehensively under various conditions to generate the derating curves with the consideration for long term reliability.

The thermal derating curves are highly influenced by the test conditions. One of the critical variables is the

interface method between the converter and the test fixture board. There is no standard method in the industry for the derating tests. Some suppliers use sockets to plug in the converter, while others solder the converter into the fixture board. It should be noticed that these two methods produce significantly different results for a given converter. When the converter is soldered into the fixture board, the thermal performance of the converter is significantly improved compared to using sockets due to the reduction of the contact loss and the thermal impedance from the pins to the fixture board. Other factors affecting the results include the board spacing, construction (especially copper weight, holes and openings) of the fixture board and the spacing board, temperature measurement method and ambient temperature measurement point. The thermal derating curves in this datasheet are obtained using a PWB fixture board and a PWB spacing board with no opening, a board-to-board spacing of 1", and the converter is soldered to the test board with thermal relieves.

Note that the natural convection condition was measured at 0.05 m/s to 0.15 m/s (10ft./min. to 30 ft./min).

Heat Transfer without a Baseplate

With single-board DC/DC converter designs, convection heat transfer is the primary cooling means for converters without a baseplate. Therefore, airflow speed should be checked carefully for the intended operating environment. Increasing the airflow over the converter enhances the heat transfer via convection.

Figure 16 shows a recommended temperature monitoring point for open frame modules. For reliable operation, the temperature at this location should not continuously exceed 120 °C.

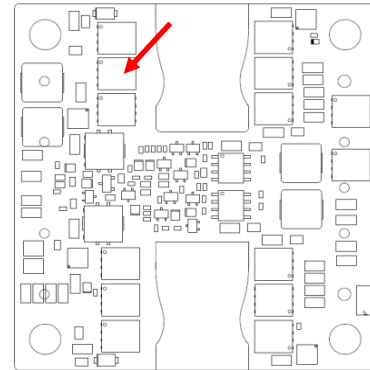

Figure 16. Temperature Monitoring Location

Heat Transfer with a Baseplate

The HPS1 Series of converters have the options of using a baseplate for enhanced thermal performance. The typical height of the converter with the baseplate option is 0.50". The use of an additional heatsink or cold-plate can further improve the thermal performance of the converter. With the baseplate option, an additional heatsink can be attached to the converter using M3 screws.

For reliable operation, the baseplate temperature should not continuously exceed 100 °C.

EMC Considerations

The EMC performance of the converter is related to the layout and filtering design of the customer board. Careful layout and adequate filtering around the converter are important to confine noise generated by the switching actions in the converter and to optimize system EMC performance.

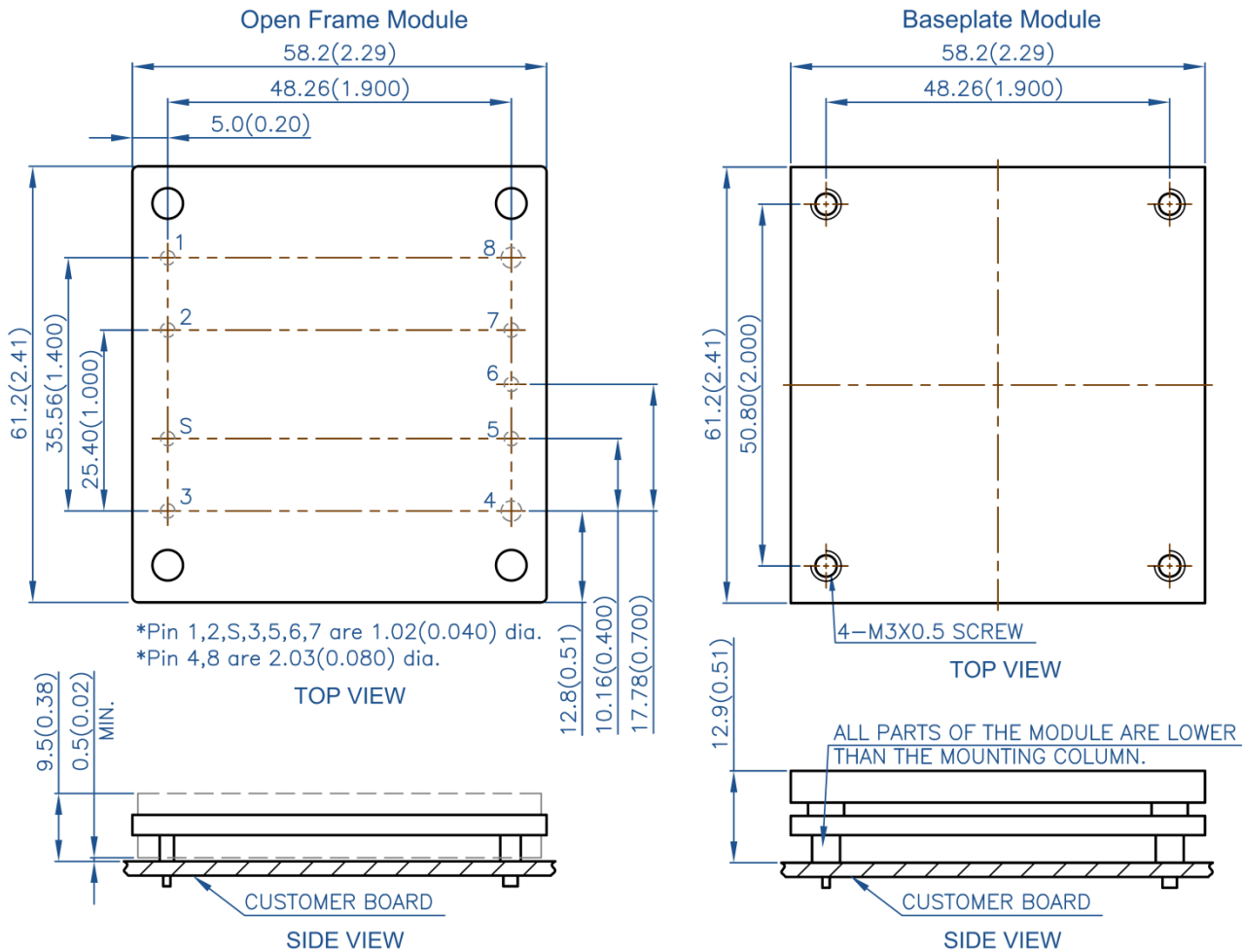
Mechanical Drawing

Pin	Name	Function
1	Vin(+)	Positive input voltage
2	ON/OFF	Remote control
S	SHARE	Current share (optional)
3	Vin(-)	Negative input voltage
4	Vout(-)	Negative output voltage
5	SENSE(-)	Negative remote sense
6	TRIM	Output voltage adjustment
7	SENSE(+)	Positive remote sense
8	Vout(+)	Positive output voltage

Notes:

- All dimensions in mm (inches)
 Tolerances: .x ± .5 (.xx ± 0.02)
 .xx ± .25 (.xxx ± 0.010)
- Input and control pins are 1.02mm (0.040") dia. with +/- 0.10mm (0.004") tolerance. The recommended diameter of the receiving hole is 1.42mm (0.056").
- Output pins are 2.03 mm (0.080") dia. with +/- 0.10mm (0.004") tolerance. The recommended diameter of the receiving hole is 2.44mm (0.096").
- All pins are coated with 90%/10% solder, Gold, or Matte Tin finish with Nickel under plating.
- Weight: 73 g open frame converter
 110 g converter with baseplate
- Workmanship meets or exceeds IPC-A-610 Class II.
- Torque applied on screw should not exceed 6in-lb. (0.7 Nm).
- Baseplate flatness tolerance is 0.10mm (0.004") TIR for surface.